



selt ✦
sun
protection
systems

THE SHADOW MAKERS

SUN SHADING SOLUTIONS

EDITION **EN**

www.selt.com

Table of contents

PERGOLAS	4
SB 500	6
SB 500R	8
SB 400	10
SB 400 PRO	12
SB 350	14
SB 400R	16
SLIDE	18
SB 400 MD	20
Solid	22
SYSTEM PERGOLA V	24
Pergola V	26
SYSTEM VERANDA V	28
Veranda V	30
VENETIAN BLINDS	32
Z 90 BOX	34
Z 90, Z 90 HF	38
Z 90 CUBE, OVAL	40
Z 90 L	42
C 80 BOX	44
C 80	48
C 80 CUBE, OVAL	50
C 80 L	52
C 80 FLAT	54
C 80 L FLAT	56
C 50 L	58
C 50 SLIM	60
REFLEKSOLS	62
125	64
120 ZiiiP	66
120 ZiiiP DZ (for concealed installation)	68
ZiiiP BOX	70
95 ZiiiP	72
120	74
120 DZ (for concealed installation)	76
MR 120	78
MR 120 DZ (for concealed installation)	80
103	82

MR 103.....	84
95.....	86
90.....	88
85 SA/MA.....	90
85 A.....	92
76.....	94
XXL.....	96
XL.....	98
XL MA.....	100
XS.....	102
VERANDAS.....	104
Veranda.....	106
Veranda FTS.....	108
AWNINGS.....	110
Dakar.....	112
Casablanca.....	114
Palladio.....	116
Corsica.....	118
Jamaica.....	120
Australia.....	122
Silver Plus.....	124
Malta.....	126
Bora.....	128
Italia Box.....	130
Italia.....	132
Italia Balcony.....	134
SUNBREAKERS.....	136
300 Rotary.....	138
300 Fixed.....	140
210 Rotary.....	142
210 Fixed.....	144
POWDER COATING.....	146
Coating finish.....	148
Construction colours.....	150
Slats colours.....	151
FABRICS.....	152
Awning fabrics.....	154
Refleksol fabrics.....	156
Pergola Solid fabrics.....	158
AUTOMATION.....	160



A photograph of a modern pergola system in a garden at dusk. The pergola has a dark frame and a white slatted top with integrated lighting. A large, leafy tree stands in the center of the garden. In the background, there is a house with a red roof and a glass-enclosed structure. The sky is dark and cloudy.

SYSTEM PERGOLA

PERGOLA SUNBREAKER 500



Colour	RAL
Electric drive	yes
Maximum projection	7 m
Maximum width	5 m
Water drainage system	yes

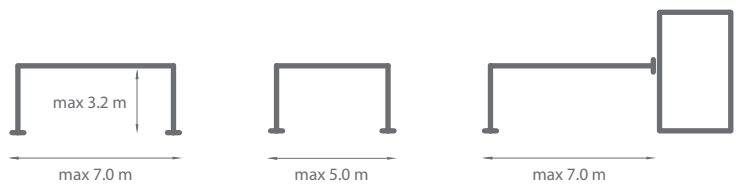

Standard construction colours:

- RAL 9016 mat
- FSM 71319
- RAL 7016 mat



Blade cross-section

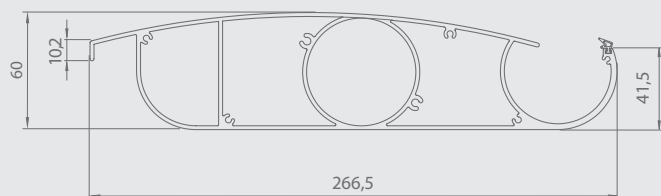

Beam cross-section

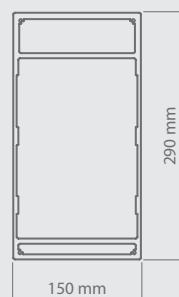

Post cross-section

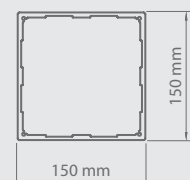



Properties:

- *Extruded aluminium construction with steel elements*
- *Water drainage system integrated with the construction*
- *Sun and waterproof system*
- *Construction and roofing painted in any RAL colour (optional)*
- *Roofing made from rotating slats*
- *Maximum dimensions of single module: 5.0 m width and 7.0 m projection*
- *Minimum dimensions of single module: 1.4 m width and 2.0 m projection*
- *Possibility of modular connection*
- *Possibility of wall-mounted and free-standing version*
- *Possibility of using sliding wall system "SLIDE" up to 2.8m high*
- *Construction in accordance with EN 1090 and EN 13659*
- *Optional LED lighting on perimeter of pergola or light points in blades*
- *Possibility of using weather automation*

PERGOLA SUNBREAKER 500R



Colour	RAL
Electric drive	yes
Maximum projection	7 m
Maximum width	5 m
Beam height	290 mm + 150 mm blades opening
Water drainage system	yes (without outflows)

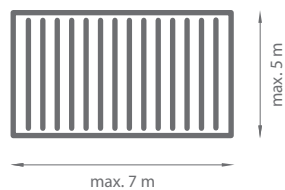

Standard construction colours:

- RAL 9016 mat
- FSM 71319
- RAL 7016 mat

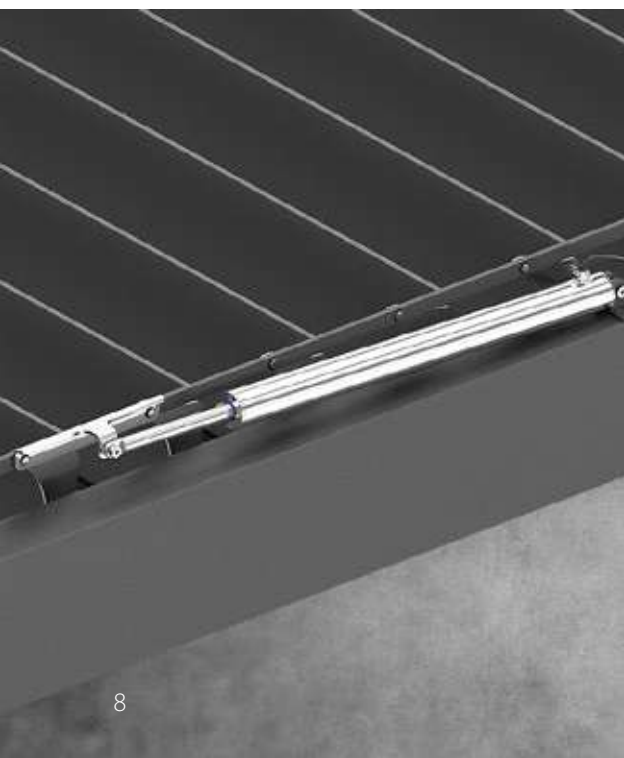

Blade cross-section

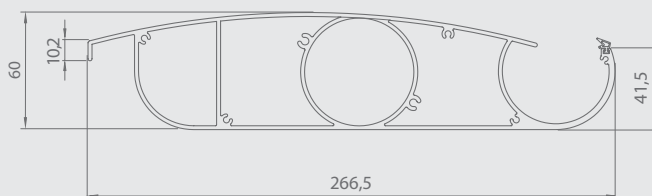

Beam cross-section

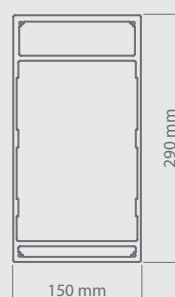



Properties:

- *The structure made of extruded aluminum profiles and steel elements*
- *The structure is equipped with a water drainage system (gutters without outflows)*
- *Sun protection and rain protection system*
- *Maximum dimensions: 5.0 m wide, projection 7.0 m*
- *Minimum dimensions: 1.4 m wide, projection 2.0 m*
- *Drain points selected individually*
- *Optional LED lighting around the pergola or light points in the blades*
- *Possibility of using weather automation*
- *6th class of wind resistance*
- *Through-anchoring of beams*

PERGOLA SUNBREAKER 400



Colour	RAL
Electric drive	yes
Maximum projection	7 m
Maximum width	4 m
Water drainage system	yes

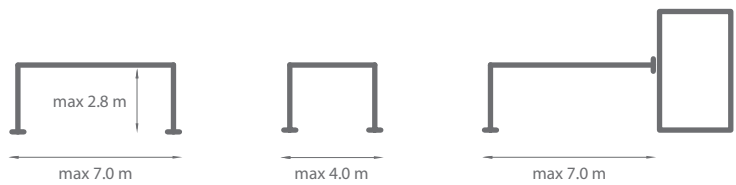

Standard construction colours:

- RAL 9016 mat
- FSM 71319
- RAL 7016 mat

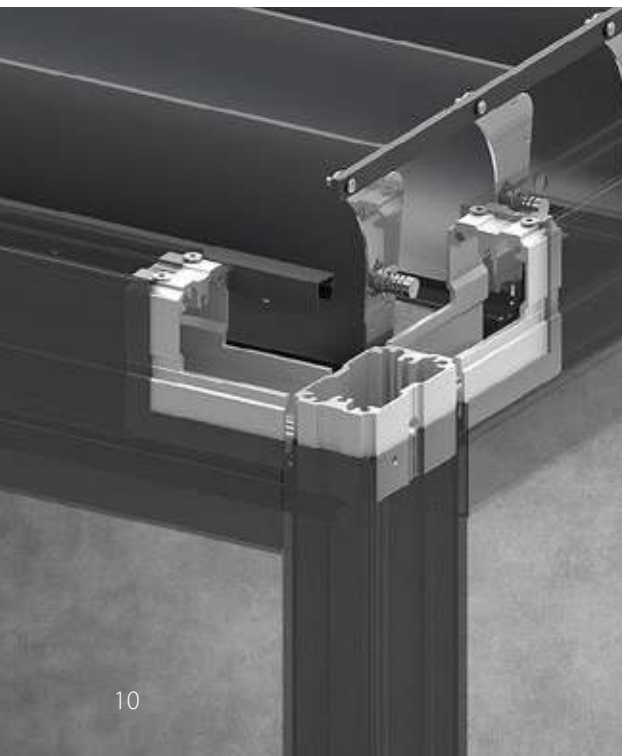

Blade cross-section

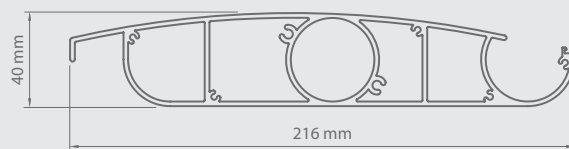

Beam cross-section

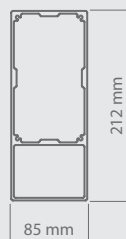

Post cross-section

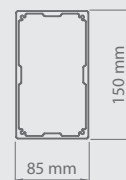



Properties:

- *Extruded aluminium construction with steel elements*
- *Water drainage system integrated with the construction*
- *Sun and waterproof system*
- *Possibility of using weather automation*
- *Construction and roofing painted in any RAL colour (optional)*
- *Roofing made from rotating slats*
- *Maximum dimensions of single module: 4.0 m width and 7.0 m projection*
- *Minimum dimensions of single module: 1.4 m width and 1.4 m projection*
- *Free-standing and wall-mounted version*
- *Construction in accordance with PN-EN 1090 and PN-EN 13659*
- *Additional chamber in the beam allows to use an invisible overflow system between the gutters (option with 4 gutters)*
- *Optional LED lighting on perimeter of pergola or light points in blades*

PERGOLA SUNBREAKER 400



Colour	RAL
Electric drive	yes
Maximum projection	7 m
Maximum width	4 m
Water drainage system	yes

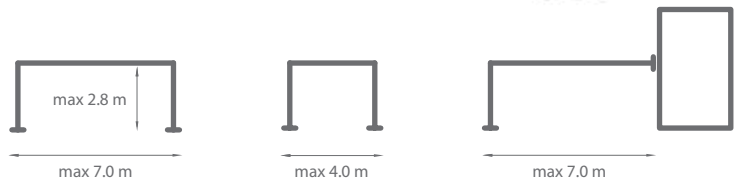

Standard construction colours:

- RAL 9016 mat
- FSM 71319
- RAL 7016 mat



Blade cross-section

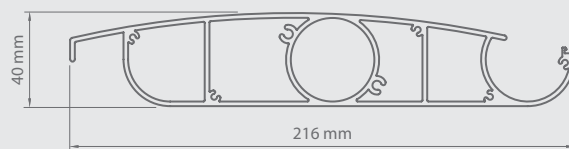

Beam cross-section

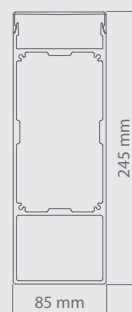

Post cross-section

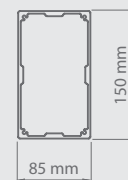



Properties:

- *Blades drive unit hidden in the beam*
- *Extruded aluminium construction with steel elements*
- *Water drainage system integrated with the construction*
- *Sun and waterproof system*
- *Possibility of using weather automation*
- *Construction and roofing painted in any RAL colour (optional)*
- *Roofing made from rotating slats*
- *Maximum dimensions of single module: 4.0 m width and 7.0 m projection*
- *Minimum dimensions of single module: 2.0 m width and 2.4 m projection*
- *Free-standing and wall-mounted version*
- *Construction in accordance with PN-EN 1090 and PN-EN 13659*
- *Additional chamber in the beam allows to use an invisible overflow system between the gutters (option with 4 gutters)*
- *Optional LED lighting on perimeter of pergola or light points in blades*
- *The upper chamber with a revision allows convenient distribution of electric installation*
- *Wall fixing concealed in the beam*



PERGOLA

SUNBREAKER 350



Electric drive	yes
Available projection	3.40 m 3.85 m 4.30 m 4.75 m
Fixed width	3.50 m
Height in the recess	2.50 m
Water drainage system	yes

Available construction/blades colours:

 RAL 9016 mat

 RAL 7016 mat

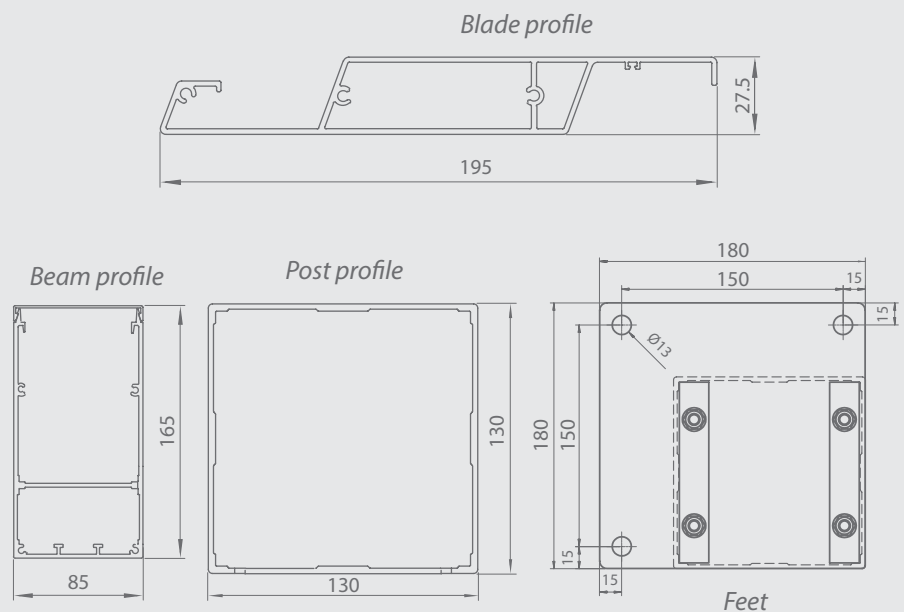



Properties:

- System available in fixed dimensions acc. to the table
- Only free-standing version available
- Blade rotation angle 120°
- Possibility to choose blades and construction in two available colours
- It is not possible to paint in other colours
- Blade drive unit hidden in the beam
- The upper chamber with a revision allows convenient distribution of electric installation
- The set includes a 24V pergola motor and a remote control
- System can be controlled via the app
- Flat blades

PERGOLA SUNBREAKER 400R



Colour	RAL
Electric drive	yes
Maximum projection	7 m
Maximum width	4 m
Beam height	290 mm + 150 mm blades opening
Water drainage system	yes (without outflows)

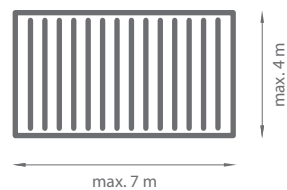

Standard construction colours:

- RAL 9016 mat
- FSM 71319
- RAL 7016 mat



Blade cross-section

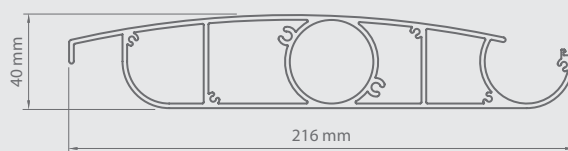

Beam cross-section

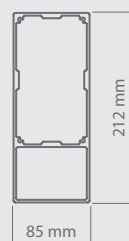



Properties:

- *The structure made of extruded aluminum profiles and steel elements*
- *The structure is equipped with a water drainage system (gutters without outflows)*
- *Sun protection and rain protection system*
- *Maximum dimensions: 4 m wide, projection 7 m*
- *Drain points selected individually*
- *Optional LED lighting around the pergola or light points in the blades*
- *Possibility of using weather automation*
- *6th class of wind resistance*
- *Wall brackets included*

SYSTEM SLIDE

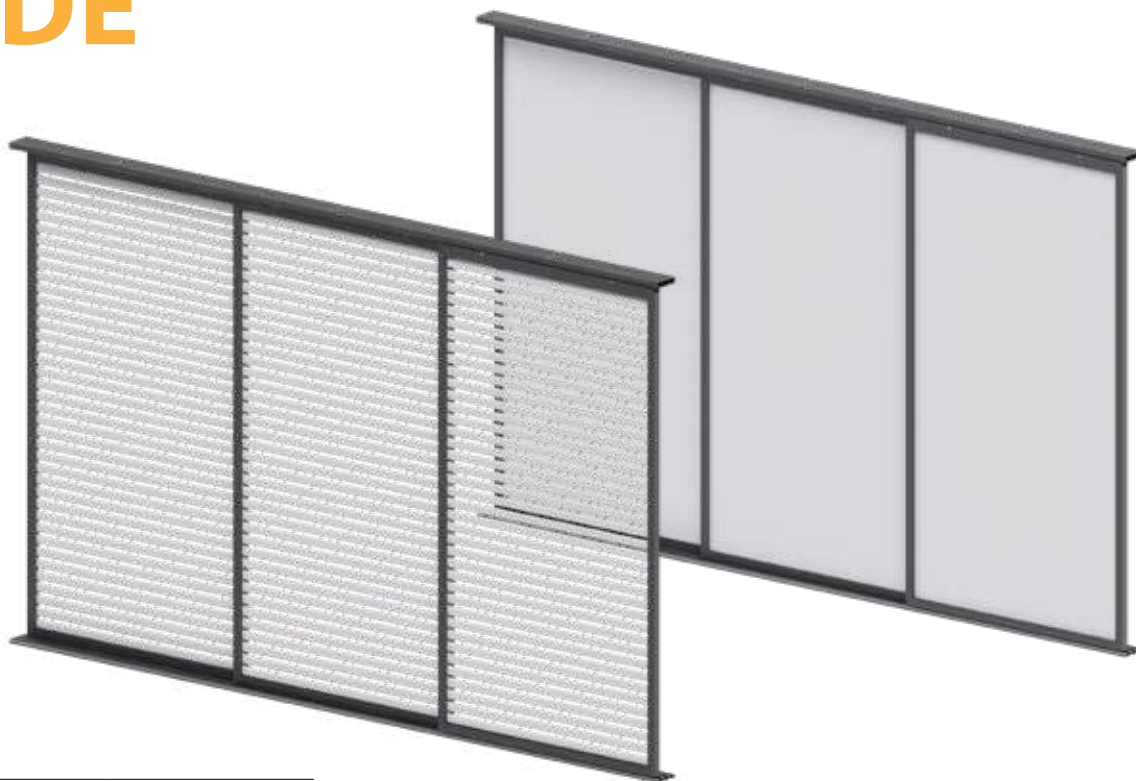

Colour	RAL
Max width of single module	1.38 m
Max height of single module	2.80 m
External use	yes
Cover	fixed blades Serge 1% fabric Serge 600 fabric

Standard construction colours:

- RAL 9016 mat
- FSM 71319
- RAL 7016 mat

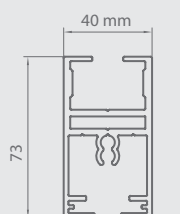
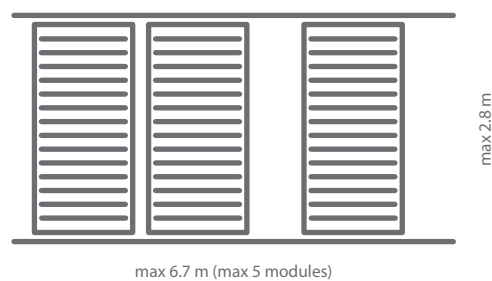

Upper frame cross-section

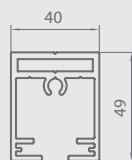

Bottom and side frame cross-section



Upper guide rail cross-section

Bottom guide rail cross-section

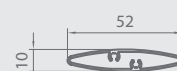
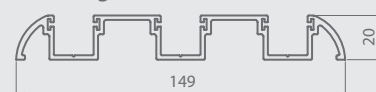

Blade cross-section



Properties:

- *Extruded aluminium construction*
- *Construction painted in any RAL colour (optional)*
- *Trolley based sliding system*
- *System equipped with a 3-track guide rail*
- *Wind resistance class 6*
- *Fixed blade angle*
- *Mixed colours available (blades + frame)*
- *SLIDE system tested in IFT Rosenheim*
- *SLIDE system is dedicated to Pergola SB500 (maximum height of 2.8 m)*

PERGOLA SUNBREAKER 400MD



Colour	RAL
Electric drive	yes
Maximum projection	7.03 m
Maximum width	4.00 m
Water drainage system	yes

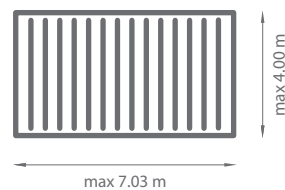

Standard construction colours:

- RAL 9016 mat
- FSM 71319
- RAL 7016 mat



Blade cross-section

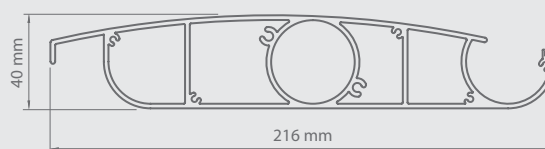

Guide rail cross-section



Properties:

- *Extruded aluminium construction*
- *Construction and roofing painted in any RAL colour (optional)*
- *Supporting subconstruction required*
- *Maximum projection 7.03 m*
- *The highest wind resistance class according to EN 13659*
- *Motor must be mounted to the supporting structure (partially outside the product outline)*
- *Gutters and sealing blades - optional*
- *Rain water pipes not included*

PERGOLA SOLID



Group installation

Colour	RAL
Electric drive	yes
Maximum projection	7 m
Maximum width	4 m
Tilt angle	5°-10°
Cover	PVC fabric dedicated for Solid system

Standard construction colours:

- RAL 9016 mat
- FSM 71319
- RAL 7016 mat

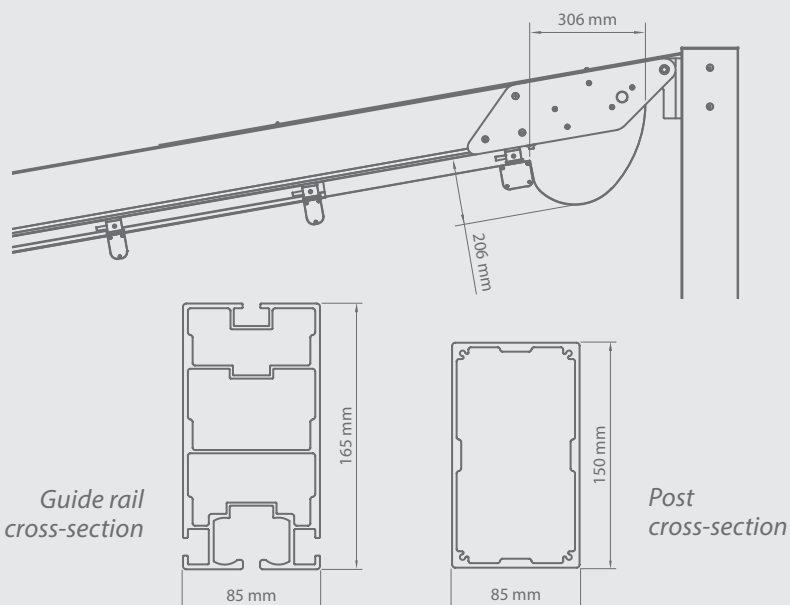
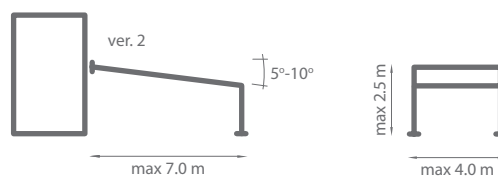
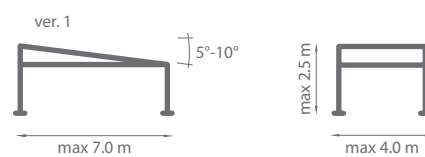



Properties:

- *Extruded aluminium construction with steel elements*
- *Water drainage system integrated with the construction*
- *Sun and waterproof system*
- *Movable roofing operated electrically*
- *Possibility of using weather automation*
- *Optional LED lighting application in the movable beams*
- *Free-standing and wall-mounted version*
- *Construction painted in any RAL colour (optional)*
- *Minimum size of one module: width 1.5 m, projection 2.0 m*
- *Maximum size of one module width 4.0 m, projection 7.0 m*
- *Possibility of modular connection*
- *Construction in accordance with EN 1090 and EN 13561*





PERGOLA **V**

SYSTEM PERGOLA V ZIPP

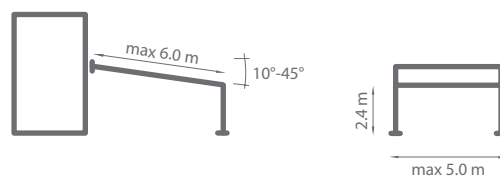
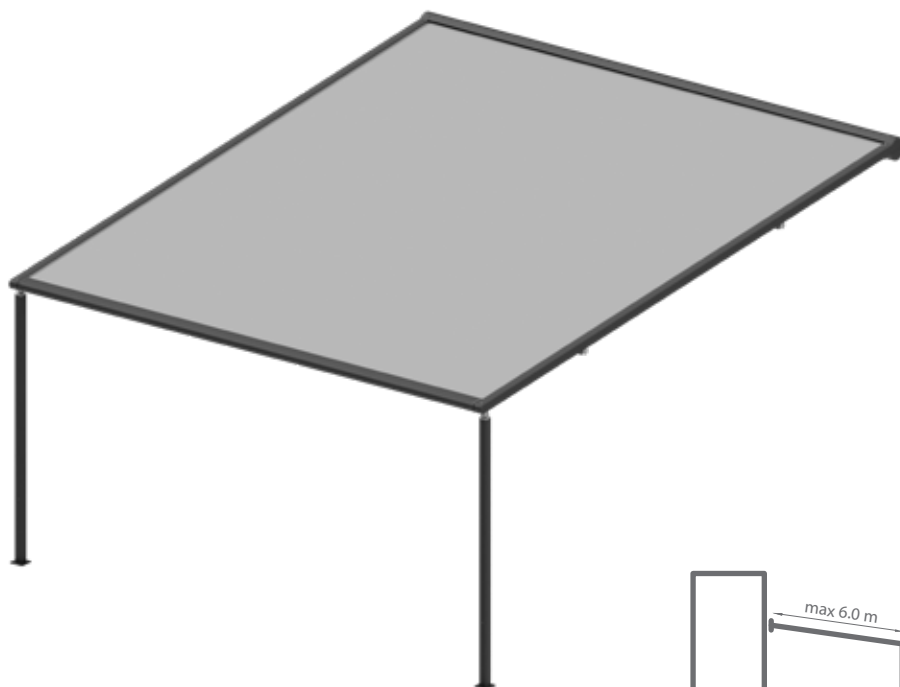

Colour	RAL
Electric drive	tak
Maximum width	5 m
Maximum projection	6 m
Tilt angle	10° - 45°
Cover	Serge 100 / Serge 600

Standard construction colours:

- RAL 9010 mat
- RAL 9006 mat
- RAL 9005 mat
- RAL 7016 mat
- FSM 71319

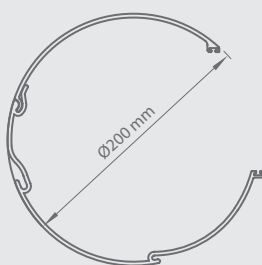

Cassette cross-section

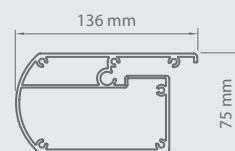

Front beam cross-section

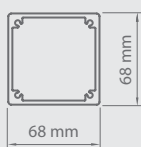

Post cross-section

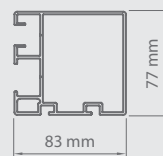

Guide rail cross-section

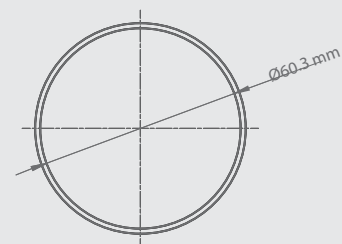

Beam stabilizing the construction



Properties:

- *Extruded aluminium construction with stainless steel elements*
- *Maximum dimensions: width 5 m, projection 6 m*
- *Possibility to connect systems with the use of modular post*
- *Wall-mounted construction*
- *Construction in accordance with PN 13561*
- *Pneumatic fabric tensioning system*
- *Serge 100 and Serge 600 fabrics*
- *Beam stabilizing the construction*





VERANDA V

SYSTEM VERANDA V ZIIP

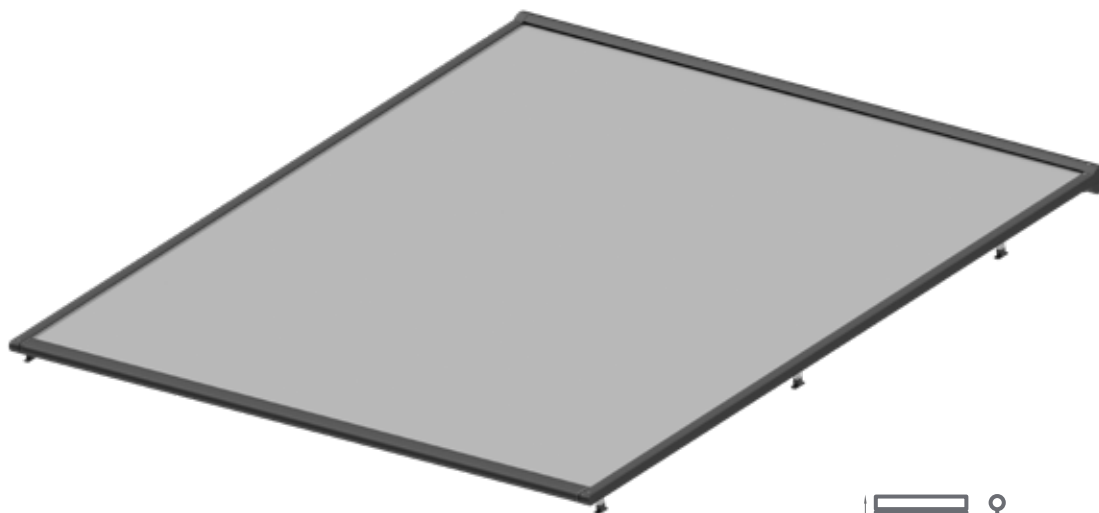

Colour	RAL
Electric drive	tak
Maximum width	5 m
Maximum projection	6 m
Tilt angle	0° - 45°
Cover	Serge 100 / Serge 600

Standard construction colours:

- RAL 9010 mat
- RAL 9006 mat
- RAL 9005 mat
- RAL 7016 mat
- FSM 71319

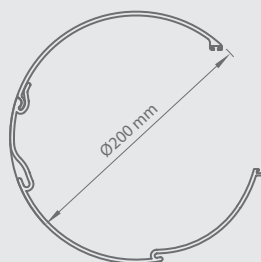

Cassette cross-section

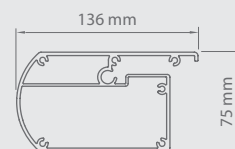

Front beam cross-section

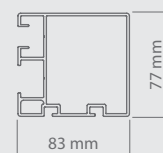

Guide rail cross-section



Properties:

- *Extruded aluminium construction with stainless steel elements*
- *Maximum dimensions: width 5 m, projection 6 m*
- *Possibility to connect systems with modular guide rail bracket*
- *Construction in accordance with PN-EN 13561*
- *Pneumatic fabric tensioning system*
- *Serge 100 and Serge 600 fabrics*





**VENETIAN
BLINDS**

VENETIAN BLIND Z90 BOX

Shape of slats	Z
Colour	RAL
Electric drive	yes
Manual drive	no
Maximum width	4.5 m
Maximum height	3.5 m
External use	yes
Internal use	no

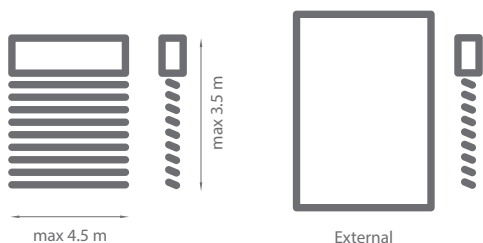

Standard construction colours:



Colours from SELT palette
pages: 150-151

Slat cross-section

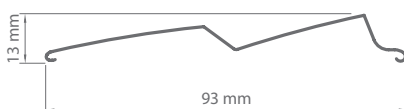

BOX 1,3

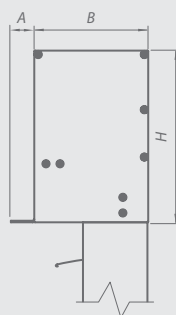

BOX 2,4

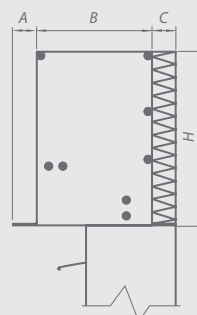

BOX 5

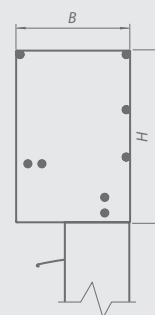

BOX 1 [mm]		
A	B	H
15	146	220
15	146	270
15	146	310
15	146	350

BOX 2 [mm]			
A	B	C	H
15	146	30	220
15	146	30	270
15	146	30	310
15	146	30	350

BOX 3 / 5 [mm]		
A	B	H
15	150	223
15	150	273
15	150	313
15	150	353

BOX 4 [mm]			
A	B	C	H
15	150	30	223
15	150	30	273
15	150	30	313
15	150	30	353



Properties:

- *BOX 1 and BOX 2 cassette for under plaster installation made from extruded aluminium, equipped with an extension made of aluminium sheet enabling external plaster application*
- *Revision lid enabling easy access and installation for BOX 1 and BOX 2 cassettes*
- *BOX 2 and BOX 4 with windowhead insulation*
- *BOX 3 and BOX 4 cassette is characterized by easy installation and increased rigidity (whole cassette made of extruded aluminium)*
- *The BOX 5 cassette is completely powder coated, it does not have a plaster carrier on the front of the cassette*
- *Z-shaped slats provide enhanced shading*
- *Textile elements made of polyester are thermally preserved and are resistant to stretching, abrasion and UV radiation, Kevlar® reinforced ladder*
- *Self-supporting system where the cassette rests on guide rails*
- *Electric drive*
- *Construction painted in any RAL colour (optional)*

VENETIAN BLIND

Z90 BOX 1 NEW

Shape of slats	Z
Colour	RAL
Electric drive	yes
Manual drive	no
Maximum width	*4.5 m
Maximum height	5.0 m
External use	yes
Internal use	no

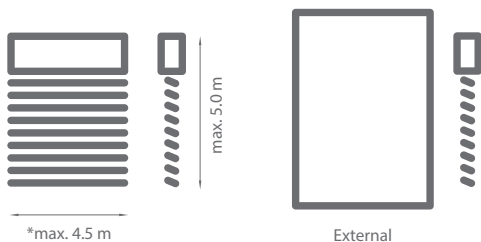

* Does not apply to Box cassettes with height of 400, 460 (maximum width 3.4 m)

Standard construction colours:



Colours from SELT palette
pages: 150-151

Slat cross-section

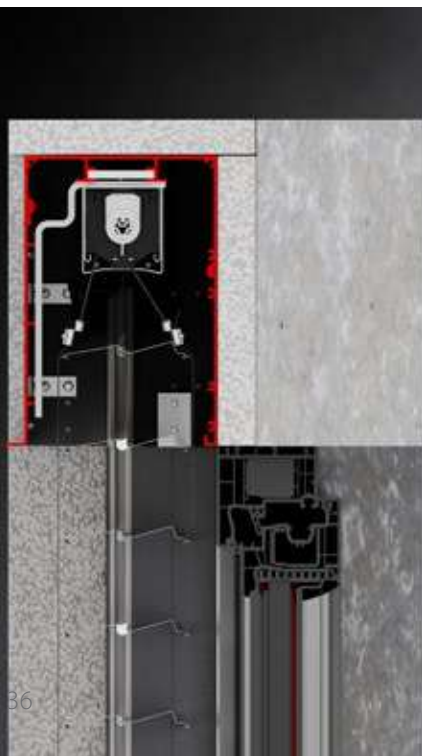
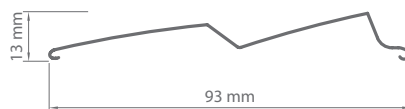

Properties:

- Available in 5 Box heights: 220 mm, 280 mm, 350 mm, *400 mm, *460 mm (*Width max 3.4 m)
- Revision cover enables easy installation
- Cassette made entirely of extruded aluminium with wall thickness of 2.2 mm

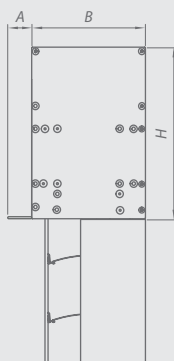

BOX 1 NEW [mm]		
A	B	H
15	146	220
15	146	280
15	146	350
15	146	400
15	146	460

VENETIAN BLIND

Z90 BOX 2 NEW

Shape of slats	Z
Colour	RAL
Electric drive	yes
Manual drive	no
Maximum width	*4.5 m
Maximum height	5.0 m
External use	yes
Internal use	no

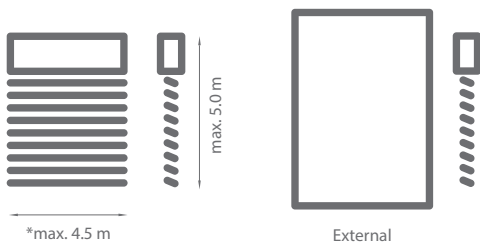

* Does not apply to Box cassettes with height of 400, 460 (maximum width 3.4 m)

Standard construction colours:



Colours from SELT palette
pages: 150-151

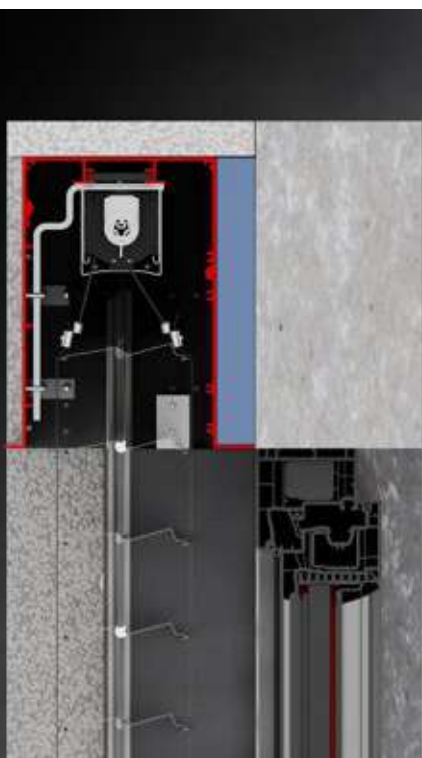
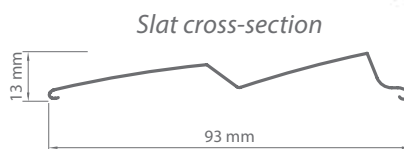

Properties:

- Available in 5 Box heights: 220 mm, 280 mm, 350 mm, *400 mm, *460 mm (*Width max 3.4 m)
- Revision cover enables easy installation
- Cassette made entirely of extruded aluminium with wall thickness of 2.2 mm
- Variant with windowhead insulation

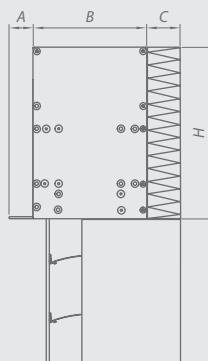

BOX 2 NEW [mm]			
A	B	C	H
15	146	30	220
15	146	30	280
15	146	30	350
15	146	30	400
15	146	30	460

VENETIAN BLIND

Z90, Z90 HF

Shape of slats	Z
Colour	RAL
Electric drive	yes
Manual drive	yes
Maximum width	4.5 m
Maximum height	5.0 m
External use	yes
Internal use	no

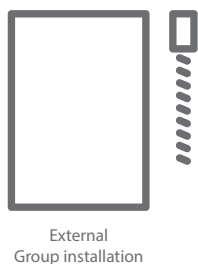

Standard construction colours:



Colours from SELT palette
pages: 150-151



System Z90 Hagofix®



System Z90

Slat cross-section





Properties:

- Aluminium cover panel 1.2 mm, 1.5mm or 2.0 mm thick in 4 types
- Extruded aluminium guide rails
- Z-shaped slats provide better shading
- Smooth control of the tilt angle of slats that makes it easy to adjust the light intensity
- The slats are equipped with silencing gasket, which helps reduce noise when completely closed
- Pins from zinc and aluminium alloy
- HAGOFIX ladder system is formed by inserting a special clip into the slat profile
- Textile elements made of polyester are thermally preserved and are resistant to stretching, abrasion and UV radiation, Kevlar® reinforced ladder
- Option to connect any number of modules
- Construction can be painted in any colour from RAL palette (optional)
- Manual or electric drive
- Self-supported version available for systems with motor and single side guides (max 2500 mm width and max 3000 mm height)

VENETIAN BLIND

Z90 CUBE, OVAL

shape of slats	Z
colour	RAL
electric drive	yes
manual drive	no
maximum width	4.5 m
maximum height	4.0 m
external use	yes
internal use	no

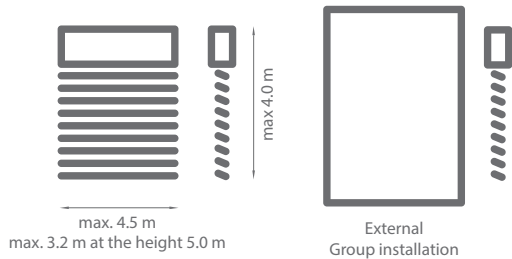

Standard construction colours:



Colours from SELT palette
pages: 150-151

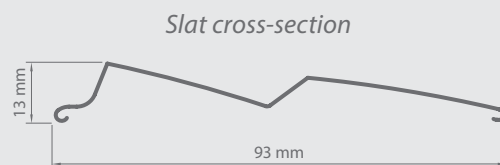



Properties:

- *Cassette and guide rails are made of extruded aluminium*
- *Z-shaped slats providing enhanced shading*
- *Smooth operation of slats tilt angle enabling easy regulation of light intensity*
- *Gasket silencing the system operation when closing*
- *Pins from zinc and aluminium alloy*
- *Polyester textile components are thermally preserved, resistant to stretching, wearing and UV radiation, ladder strengthened with Kevlar®*
- *Option to connect any number of modules*
- *Construction can be painted in any RAL colour (optional)*
- *Electric drive*
- *Self-supporting system up to 3 m wide*

VENETIAN BLIND

Z90 L

shape of slats	Z
colour	RAL
electric drive	yes
manual drive	yes
maximum width	3.5 m
maximum height	4.0 m
external use	yes
internal use	no

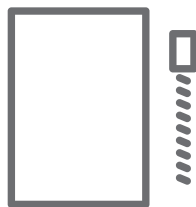

External
Group installation



Standard construction colours:



Colours from SELT palette
pages: 152-153



Slat cross-section





Properties:

- Aluminium cover panel 1.2 mm, 1.5 mm or 2.0 mm thick in 4 types
- Galvanized steel cable guides braided polyamide with a diameter of 3 mm
- Z-shaped slats providing enhanced shading
- Smooth operation of slats tilt angle enabling easy regulation of light intensity
- Gasket silencing the system operation when closing
- Polyester textile components are thermally preserved, resistant to stretching, wearing and UV radiation, ladder strengthened with Kevlar®
- Option to connect any number of modules
- Available modular brackets
- Construction can be painted in any RAL colour (optional)
- Manual or electric drive

VENETIAN BLIND C80 BOX

Shape of slats	C
Colour	RAL
Electric drive	yes
Manual drive	no
Maximum width	4.5 m
Maximum height	3.0 m
External use	yes
Internal use	no

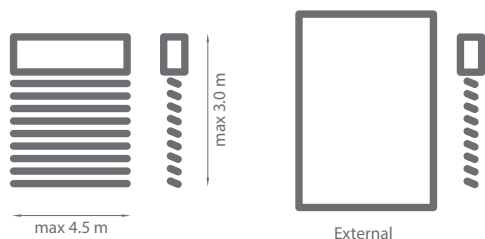

Standard construction colours:



Colours from SELT palette
pages: 150-151

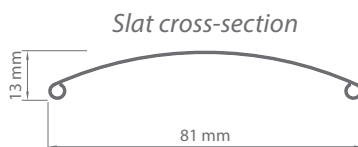

BOX 1,3

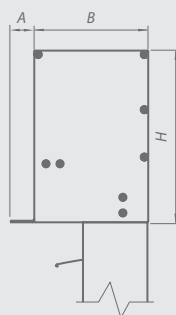

BOX 2,4

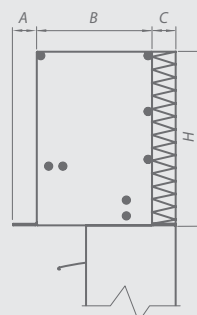

BOX 5

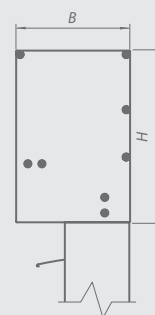

BOX 1 [mm]		
A	B	H
15	146	220
15	146	270
15	146	310
15	146	350

BOX 2 [mm]			
A	B	C	H
15	146	30	220
15	146	30	270
15	146	30	310
15	146	30	350

BOX 3/5 [mm]		
A	B	H
15	150	223
15	150	273
15	150	313
15	150	353

BOX 4 [mm]			
A	B	C	H
15	150	30	223
15	150	30	273
15	150	30	313
15	150	30	353



Properties:

- *BOX 1 and BOX 2 cassette for under plaster installation made from extruded aluminium, equipped with an extension made of aluminium sheet enabling external plaster application*
- *Revision lid enabling easy access and installation for BOX 1 and BOX 2 cassettes*
- *BOX 2 and BOX 4 with windowhead insulation*
- *BOX 3 and BOX 4 cassette is characterized by easy installation and increased rigidity (whole cassette made of extruded aluminium)*
- *The BOX 5 cassette is completely powder coated, it does not have a plaster carrier on the front of the cassette*
- *C-shaped slats with rolled edges providing additional strength*
- *Textile elements made of polyester are thermally preserved and are resistant to stretching, abrasion and UV radiation, Kevlar® reinforced ladder*
- *Self-supporting system where the cassette rests on guide rails*
- *Electric drive*
- *Construction can be painted in any RAL colour (optional)*

VENETIAN BLIND

C80 BOX 1 NEW

Shape of slats	C
Colour	RAL
Electric drive	yes
Manual drive	no
Maximum width	*4.5 m
Maximum height	5.0 m
External use	yes
Internal use	no

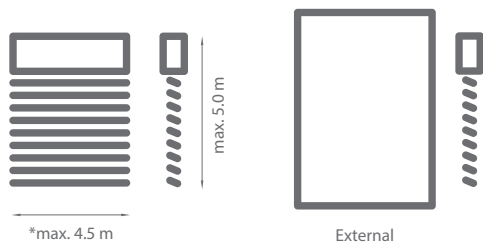

* Does not apply to Box cassettes with height of 400, 460 (maximum width 3.4 m)

Standard construction colours:



Colours from SELT palette
pages: 150-151

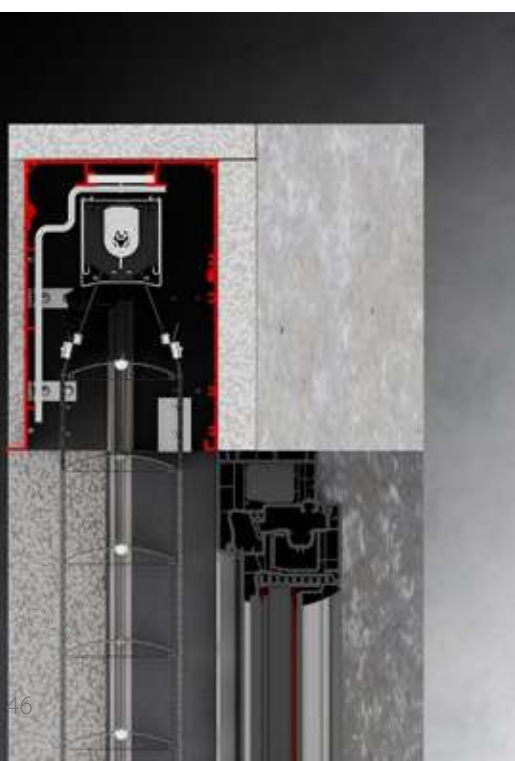
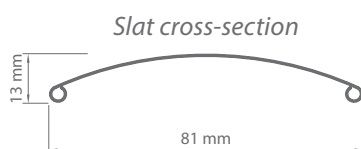

Properties:

- Available in 5 Box heights: 220 mm, 280 mm, 350 mm, *400 mm, *460mm (*Width max 3.4 m)
- Revision cover enables easy installation
- Cassette made entirely of extruded aluminium with wall thickness of 2.2 mm

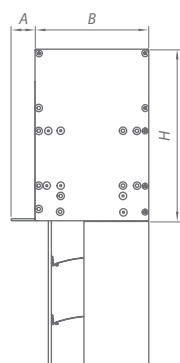

BOX 1 NEW [mm]		
A	B	H
15	146	220
15	146	280
15	146	350
15	146	400
15	146	460

VENETIAN BLIND

C80 BOX 2 NEW

Shape of slats	C
Colour	RAL
Electric drive	yes
Manual drive	no
Maximum width	*4.5 m
Maximum height	5.0 m
External use	yes
Internal use	no

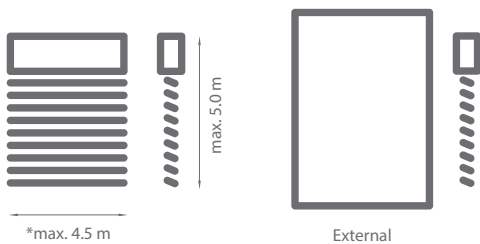

* Does not apply to Box cassettes with height of 400, 460 (maximum width 3.4 m)

Standard construction colours:



Colours from SELT palette
pages: 150-151

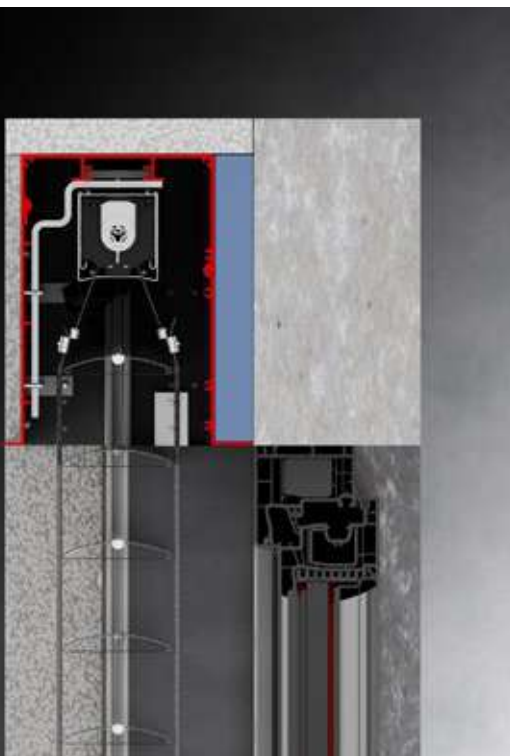
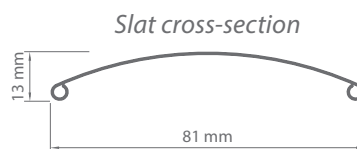

Properties:

- Available in 5 Box heights: 220 mm, 280 mm, 350 mm, *400 mm, *460 mm (*Width max 3.4 m)
- Revision cover enables easy installation
- Cassette made entirely of extruded aluminium with wall thickness of 2.2 mm
- Variant with windowhead insulation

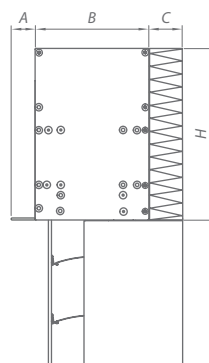

BOX 2 NEW [mm]			
A	B	C	H
15	146	30	220
15	146	30	280
15	146	30	350
15	146	30	400
15	146	30	460

VENETIAN BLIND

C80

Shape of slats	C
Colour	RAL
Electric drive	yes
Manual drive	yes
Maximum width	4.5 m
Maximum height	5.0 m
External use	yes
Internal use	no

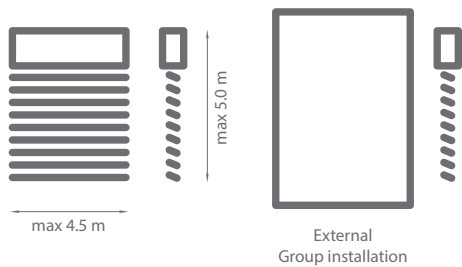

Standard construction colours:



Colours from SELT palette
pages: 150-151



Slat cross-section

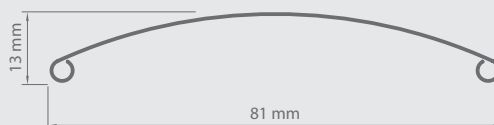



Properties:

- *Aluminium cover panel 1.2 mm, 1.5 mm or 2.0 mm thick in 4 types*
- *C-shaped slats with rolled edges providing additional strength*
- *Smooth control of the tilt angle of slats that makes it easy to adjust the light intensity*
- *Extruded aluminium guide rails*
- *Self-supporting version available for Cube or Oval systems*
- *Wrapped openings for tapes to protect from abrasion*
- *Textile elements made of polyester are thermally preserved and are resistant to stretching, abrasion and UV radiation, Kevlar® reinforced ladder*
- *Option to connect any number of modules*
- *Manual or electric drive*
- *Construction can be painted in any RAL colour (optional)*
- *Self-supported version available for systems with motor and single side guides (max 2500 mm width and max 3000 mm height)*

VENETIAN BLIND

C80 CUBE, OVAL

Shape of slats	C
Colour	RAL
Electric drive	yes
Manual drive	no
Maximum width	4.5 m
Maximum height	4.0 m
External use	yes
Internal use	no

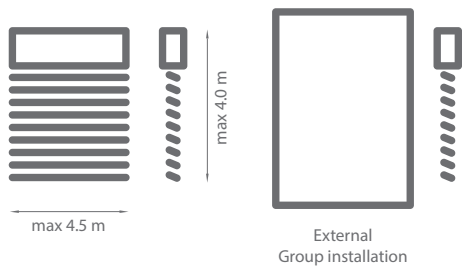

Standard construction colours:



Colours from SELT palette
pages: 150-151



C80 OVAL



C80 CUBE



Slat cross-section

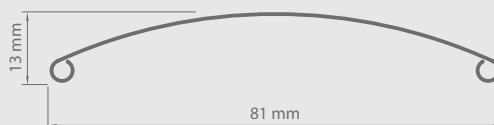



Properties:

- *Cassette and guide rails are made of extruded aluminium*
- *C-shaped slats with rolled edges providing additional strength*
- *Smooth control of the tilt angle of slats that makes it easy to adjust the light intensity*
- *Wrapped openings for tapes to protect from abrasion*
- *Pins from zinc and aluminium alloy*
- *Self-supporting version available for Cube or Oval systems*
- *Textile elements made of polyester are thermally preserved and are resistant to stretching, abrasion and UV radiation, Kevlar® reinforced ladder*
- *Construction can be painted in any RAL colour (optional)*
- *Option to connect any number of modules*
- *Electric drive*
- *Self-supporting system up to 3 m wide*

VENETIAN BLIND

C80 L

Shape of slats	C
Colour	RAL
Electric drive	yes
Manual drive	yes
Maximum width	3.5 m
Maximum height	4.0 m
External use	yes
Internal use	no

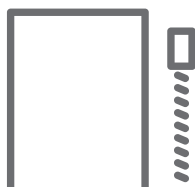
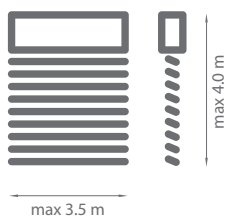

External
Group installation



Standard construction colours:



Colours from SELT palette
pages: 150-151



Slat cross-section

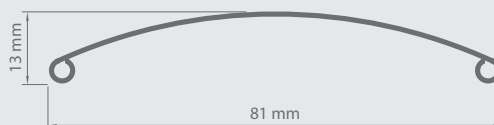



Properties:

- Aluminium cover panel 1.2 mm, 1.5 mm or 2.0 mm thick in 4 types
- Galvanized steel cable guides braided polyamide with a diameter of 3 mm
- C-shaped slats with rolled edges providing additional strength
- Smooth control of the tilt angle of slats that makes it easy to adjust the light intensity
- Wrapped openings for tapes to protect from abrasion
- Textile elements made of polyester are thermally preserved and are resistant to stretching, abrasion and UV radiation, Kevlar® reinforced ladder
- Construction can be painted in any RAL colour (optional)
- Option to connect any number of modules
- Available modular brackets
- Manual or electric drive

VENETIAN BLIND

C80 FLAT

Shape of slats	C
Colour	RAL
Electric drive	yes
Manual drive	yes
Maximum width	3.5 m
Maximum height	4.0 m
External use	yes
Internal use	no

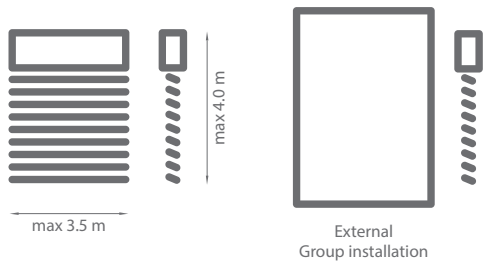

Standard construction colours:



Colours from SELT palette
pages: 150-151



Slat cross-section

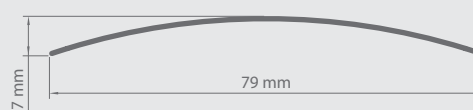



Properties:

- Aluminium cover panel 1.2 mm, 1.5 mm or 2.0 mm thick in 4 types
- Flat C-shaped slats of 0.4 mm thickness made from aluminium sheet
- The minimum height of the bundle
- Slats fitted with plastic parts
- Smooth control of the tilt angle of slats that makes it easy to adjust the light intensity
- Extruded aluminium guide rails
- Polyester textile components are thermally preserved, resistant to stretching, wearing and UV radiation, ladder strengthened with Kevlar®
- Option to connect any number of modules
- Manual or electric drive
- Construction can be painted in any RAL colour (optional)

VENETIAN BLIND

C80 L FLAT

Shape of slats	C
Colour	RAL
Electric drive	yes
Manual drive	yes
Maximum width	3.5 m
Maximum height	4.0 m
External use	yes
Internal use	yes

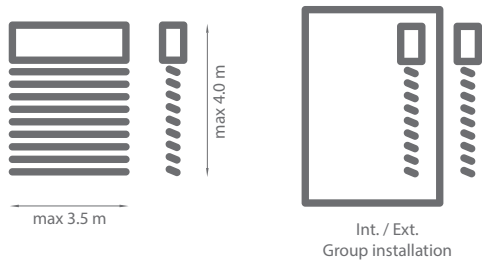

Standard construction colours:



Colours from SELT palette
pages: 150-151



Slat cross-section

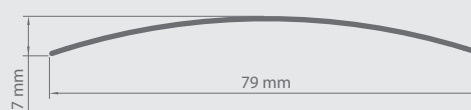



Properties:

- Aluminium cover panel 1.2 mm, 1.5 mm or 2.0 mm thick in 4 types
- Flat C-shaped slats of 0.4 mm thickness made from aluminium sheet
- The minimum height of the bundle
- Slats fitted with plastic parts
- Smooth control of the tilt angle of slats that makes it easy to adjust the light intensity
- Galvanized steel cable guides braided polyamide
- Textile elements made of polyester are thermally preserved and are resistant to stretching, abrasion and UV radiation, Kevlar® reinforced ladder
- Option to connect any number of modules
- Manual or electric drive
- Construction can be painted in any RAL colour (optional)
- Available modular brackets

VENETIAN BLIND

C50 L

Shape of slats	C
Colour	RAL
Electric drive	yes
Manual drive	yes
Internal use	yes
• max. width and height	3.0 m
External use	yes
• max. width and height	2.5 m

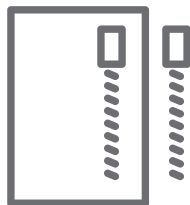

Int. / Ext.
Group installation



Standard construction colours:



Colours from SELT palette
pages: 150-151



Slat cross-section

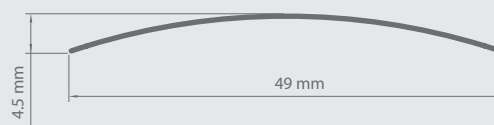



Properties:

- Aluminium cover panel 1.2 mm, 1.5 mm or 2.0 mm thick in 2 types
- C-shaped slats of 49 mm width
- Smooth control of the tilt angle of slats that makes it easy to adjust the light intensity
- Galvanized steel cable guides (2.5 mm) braided polyamide with a diameter of 3 mm
- Textile elements made of polyester are thermally preserved and are resistant to stretching, abrasion and UV radiation, Kevlar® reinforced ladder
- Option to connect any number of modules
- Construction can be painted in any RAL colour (optional)
- Manual or electric drive
- Modular brackets available

VENETIAN BLIND INTERNAL

C50 SLIM

Shape of slats	C
Colour	*
Electric drive	yes
Manual drive	yes
Maximum width	4.0 m
Maximum height	3.5 m
External use	nie
Internal use	yes

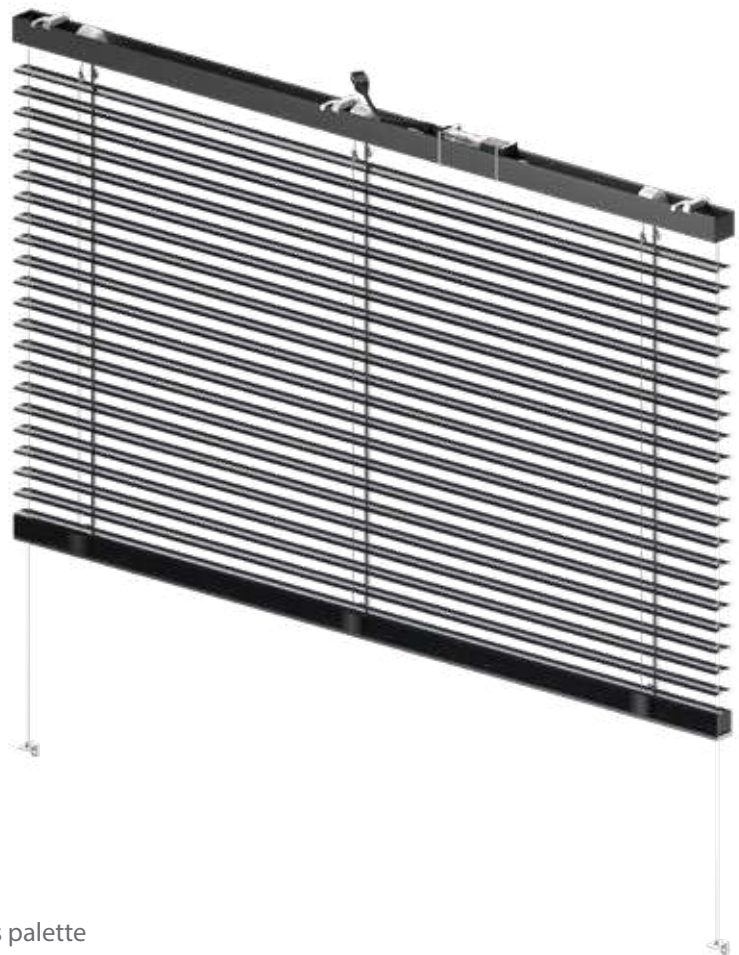
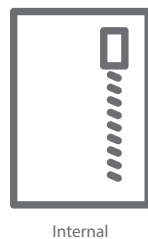
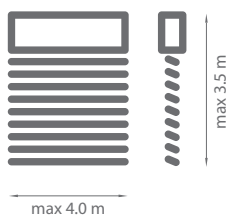

slats colours:



* - slats colours according to manufacturer's palette



Slat cross-section

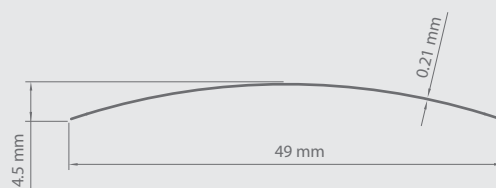



Properties:

- *Reversed head rail from extruded aluminium*
- *The ability to hide the blind in the niche or suspended ceiling*
- *Flat C-shaped slats of 0.21 mm thickness*
- *Slats with the addition of magnesium for durability and flexibility*
- *Smooth control of the tilt angle of slats that makes it easy to adjust the light intensity*
- *Optional perforated slats*
- *Textile elements made of polyester are thermally preserved and are resistant to stretching, abrasion and UV radiation, Kevlar® reinforced ladder*
- *Galvanized steel cable guides 1.6 mm thick braided polyamide or free-hanging version*
- *Minimized bundle height*
- *Manual or electric drive*



A modern office interior featuring a large window on the left side, providing a view of an urban landscape. In the foreground, two bright yellow chairs with wooden legs are positioned around a dark table. In the middle ground, a light grey sofa is placed on a dark carpet. The background shows a glass-walled office space with wooden paneling and another sofa. The ceiling is white with recessed lighting and a circular air vent.

SYSTEM REFLEKSOL

REFLEKSOL 125

Colour	RAL
Electric drive	yes
Manual drive	no
Maximum width	3.50 m
Maximum height	4.25 m
External use	yes
Internal use	no

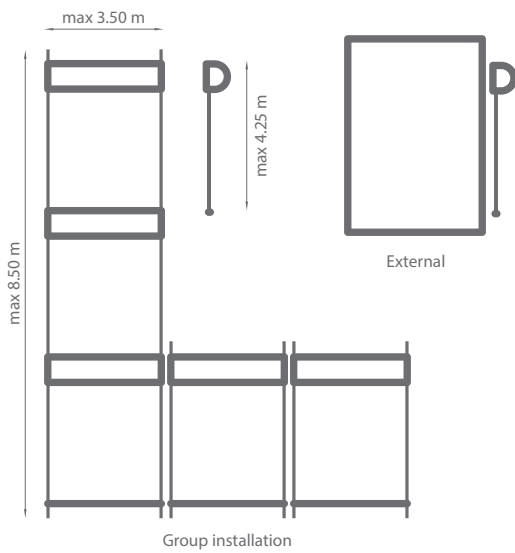

Standard construction colours:



Colours from SELT palette
pages: 150-151

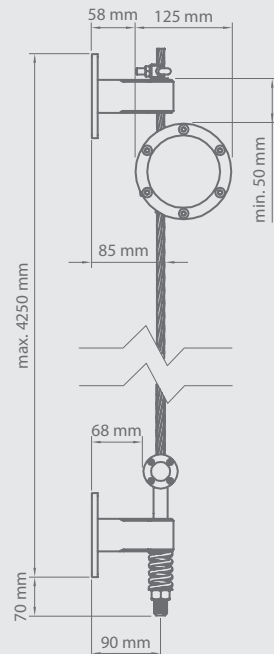



Properties:

- *Cassette made of round-shaped extruded aluminium*
- *Cable guides made of stainless steel 10 mm diameter*
- *Wide range of fabrics*
- *Access to revision from the front of the system*
- *Electric drive*
- *Dedicated for facade installation*
- *Option to create modules vertically (up to 8.5 m) and horizontally*
- *Construction available in any colour from RAL palette (optional)*

REFLEKSOL 120 ZIIP

Colour	RAL
Electric drive	yes
Manual drive	no
Maximum width	7 m
Maximum height	4 m
External use	yes
Internal use	no

Standard construction colours:



Colours from SELT palette
pages: 150-151

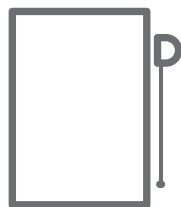
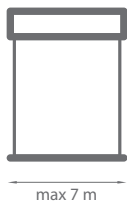

External

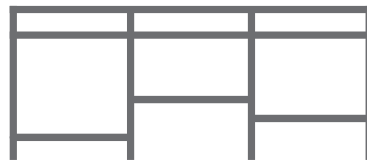

Group installation



Cassette dimensions

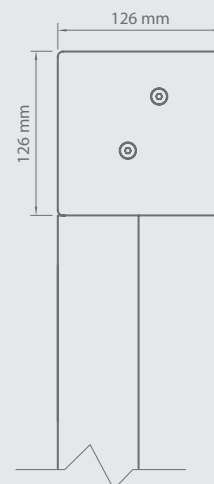



Properties:

- *Wind resistance class 6 (from 4001mm wide Class 4)*
- *Extruded aluminium cassette dedicated for niche and facade installation*
- *ZiiiP mechanism*
- *Two-piece guide rail with compensating gaskets*
- *Option to create modules using modular brackets*
- *Self-supporting system*
- *Electric drive*
- *Construction available in any colour from RAL palette (optional)*
- *For widths over 5m wide ZOOMTECH® technology will be used*

REFLEKSOL

120 ZIIP

FOR CONCEALED INSTALLATION

Colour	RAL
Electric drive	yes
Manual drive	no
Maximum width	7 m
Maximum height	4 m
External use	yes
Internal use	no

Standard construction colours:



Colours from SELT palette
pages: 150-151

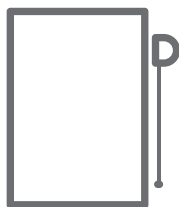
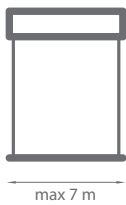

External

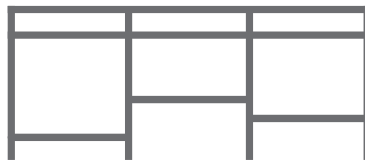

Group installation



Cassette dimensions

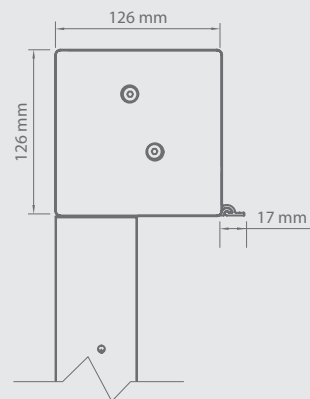



Properties:

- *Wind resistance class 6 (from 4001mm wide Class 4)*
- *Cassette for under plaster installation made from aluminium sheet, equipped with an extension enabling external plaster application*
- *ZiiiP mechanism*
- *Revision from the bottom of the cassette*
- *Option to create modules using modular brackets*
- *Two-piece guide rail with compensating gaskets*
- *Electric drive*
- *Self-supporting system*
- *Construction available in any colour from RAL palette (optional)*
- *For widths over 5m wide ZOOMTECH® technology will be used*

REFLEKSOL ZIMP BOX

Colour	RAL
Electric drive	yes
Manual drive	no
Maximum width	4 m
Maximum height	4 m
External use	yes
Internal use	no

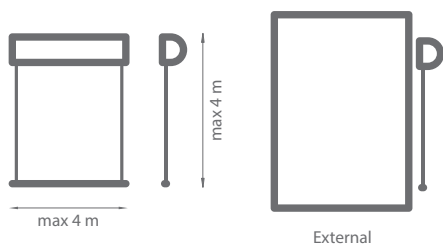

Standard construction colours:



Colours from SELT palette
pages: 150-151



Cassette dimensions

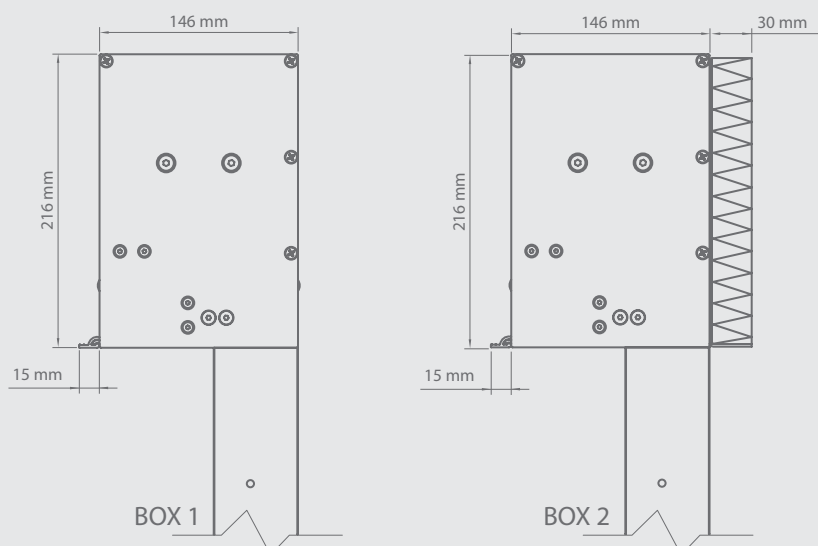



Properties:

- *Wind resistance class 6*
- *Cassette for under plaster installation made from extruded aluminium, equipped with an extension enabling external plaster application*
- *ZiiiP mechanism*
- *Two revision lids enabling easy access and installation*
- *Two-piece guide rail with compensating gaskets system*
- *Bottom bar concealed in the cassette*
- *Box 2 with windowhead insulation*
- *Wide range of fabrics*
- *Electric drive*
- *Available self-supporting version where the cassette rests on guide rails*
- *Construction painted in any RAL colour (optional)*

REFLEKSOL 95 ZIIP

Colour	RAL
Electric drive	yes
Manual drive	no
Maximum width	2.7 m
Maximum height	3.0 m
External use	yes
Internal use	no

Standard construction colours:



Colours from SELT palette
pages: 150-151

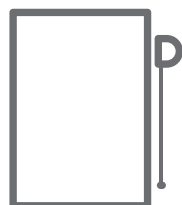
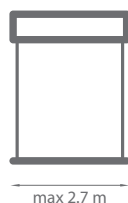

External

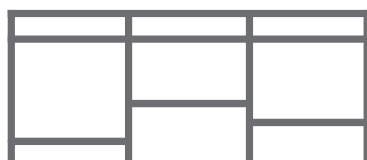

Group installation



Cassette dimensions

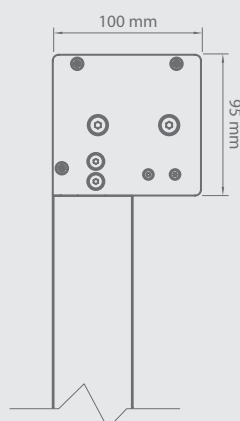



Properties:

- *Wind resistance class 6*
- *Cassette for niche or wall installation made from extruded aluminium*
- *Ziip mechanism*
- *Revision from the front of the cassette*
- *Two-piece guide rail with compensating gaskets*
- *Electric drive*
- *Self-supporting system*
- *Construction available in any colour from RAL palette (optional)*
- *Option to create modules using modular brackets*

REFLEKSOL 120

Colour	RAL
Electric drive	yes
Manual drive	no
Extruded aluminium sideguides	
• maximum width	4.0 m
• maximum height	4.0 m
Cable guide	
• maximum width	3.5 m
• maximum height	3.0 m

Standard construction colours:



Colours from SELT palette
pages: 150-151

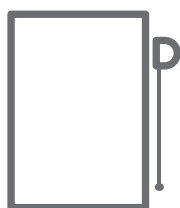
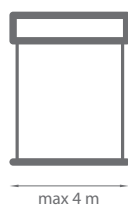

External

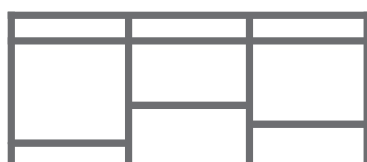

Group installation



Cassette dimensions

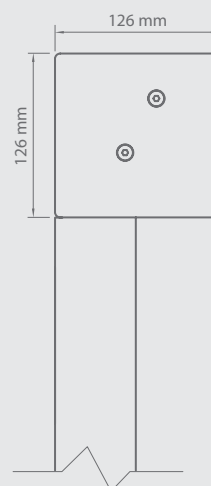



Properties:

- *Cassette for niche or facade installation made of extruded aluminum*
- *Rail guides made of extruded aluminum or cable guide made of stainless steel*
- *Revision from the front of the cassette*
- *Wide range of fabrics*
- *Electric drive*
- *Self-supporting option available*
- *Option to connect systems through common modular guide rail*
- *Construction available in any colour from RAL palette (optional)*
- *Anti-wind bars option available*

REFLEKSOL

120

FOR CONCEALED INSTALLATION

Colour	RAL
Electric drive	yes
Manual drive	no
Extruded aluminium sideguides	
• maximum width	4.0 m
• maximum height	4.0 m
Cable guide	
• maximum width	3.5 m
• maximum height	3.0 m

Standard construction colours:



Colours from SELT palette
pages: 150-151

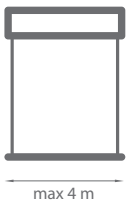

max 4 m



max 4 m

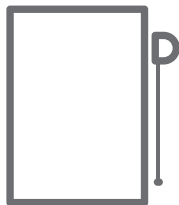

External

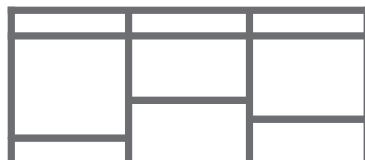

Group installation



Cassette dimensions

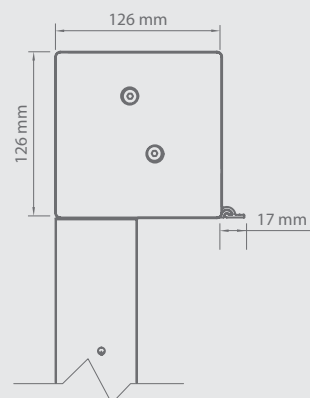



Properties:

- *Cassette dedicated for concealed installation made of aluminium sheet. The cassette has an extension that enables putting plaster on it*
- *Rail guides made of extruded aluminum or cable guide made of stainless steel*
- *Revision from the bottom of the cassette*
- *Electric drive*
- *Self-supporting option available*
- *Construction available in any colour from RAL palette (optional)*
- *Wide range of fabrics*
- *Option to connect systems through common modular guide rail*
- *Anti-wind bars option available*

MARKISOLETTE

120

Colour	RAL
Electric drive	yes
Manual drive	no
Maximum width	3.5 m
Maximum height	4.0 m
External use	yes
Internal use	no

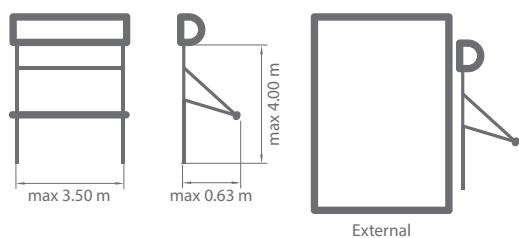

Group installation

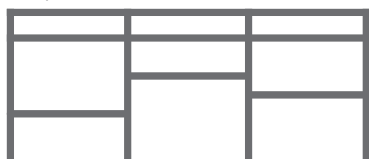

Standard construction colours:



Colours from SELT palette
pages: 150-151



Cassette dimensions

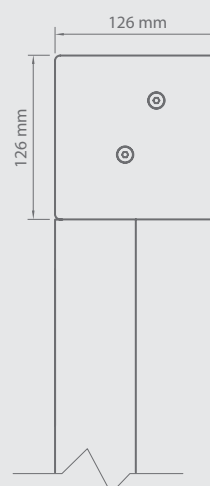



Properties:

- *Cassette for niche, wall or facade installation made of extruded aluminium*
- *Extruded aluminium sideguides*
- *Special arm creating the maximum tilt angle of 135°*
- *Self-supporting option available*
- *Revision from the front of the cassette*
- *Wide range of fabrics*
- *Electric drive*
- *Construction available in any colour from RAL palette (optional)*
- *Option to connect systems through common modular guide rail*

MARKISOLETTE

120

FOR CONCEALED INSTALLATION

Colour	RAL
Electric drive	yes
Manual drive	no
Maximum width	3.5 m
Maximum height	4.0 m
External use	yes
Internal use	no

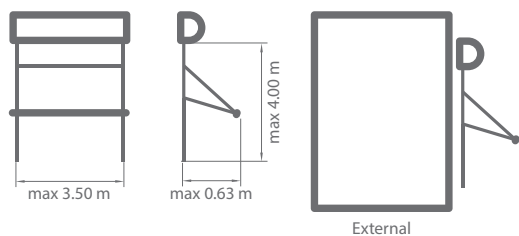

Group installation

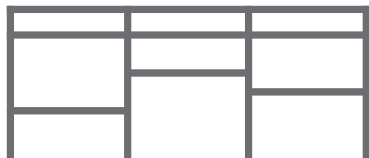

Standard construction colours:



Colours from SELT palette
pages: 150-151



Cassette dimensions

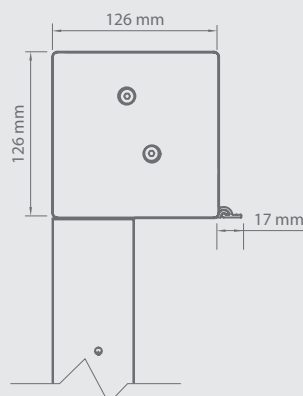



Properties:

- *Cassette for concealed installation made of extruded aluminium is equipped with an extension enabling external plaster application*
- *Extruded aluminium sideguides*
- *Special arm creating the maximum tilt angle of 135°*
- *Self-supporting option available*
- *Revision from the front of the cassette*
- *Wide range of fabrics*
- *Electric drive*
- *Construction available in any colour from RAL palette (optional)*
- *Option to connect systems through common modular guide rail*

REFLEKSOL 103

Colour	RAL
Electric drive	yes
Manual drive	yes
Extruded sideguides	
• maximum width	4.5 m
• maximum height	4.0 m
External use - cable guides	
• maximum width	3.5 m
• maximum height	3.0 m
Internal use - cable guides	
• maximum width	4.5 m
• maximum height	4.0 m



Standard construction colours:



Colours from SELT palette
pages: 150-151

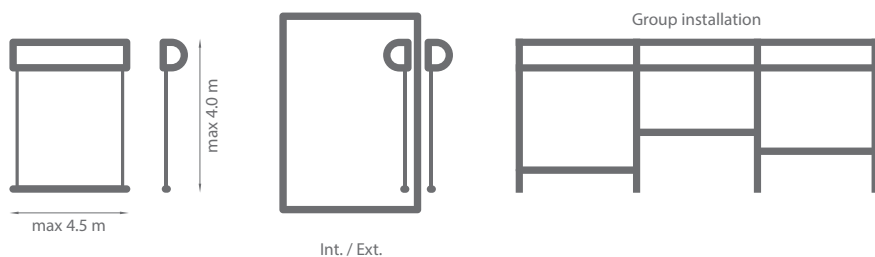

Cassette dimensions

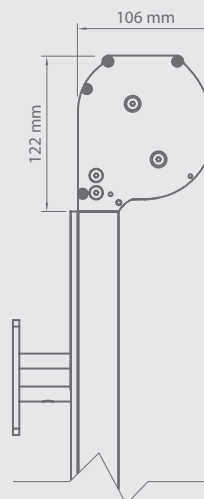



Properties:

- *Cassette made of extruded aluminium*
- *Revision from the front of the cassette*
- *Extruded aluminium sideguides or cable guides made of stainless steel*
- *Anti-wind bars option available*
- *Wide range of fabrics*
- *Manual or electric drive*
- *Dedicated for the wall, niche and facade installation*
- *Option to create modules using common guide rail and modular brackets*
- *Self-supporting option available*
- *Construction available in any colour from RAL palette (optional)*

MARKISOLETTE

103

Colour	RAL
Electric drive	yes
Manual drive	yes
Maximum width	3.5 m
Maximum height	4.0 m
External use	yes
Internal use	no

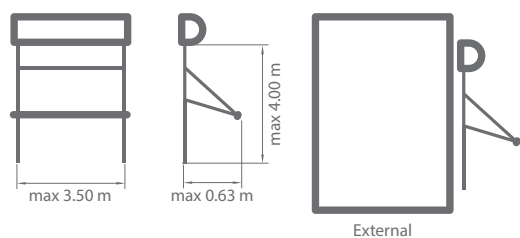

Group installation

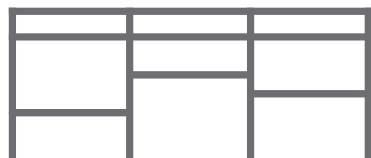

Standard construction colours:



Colours from SELT palette
pages: 150-151



Cassette dimensions

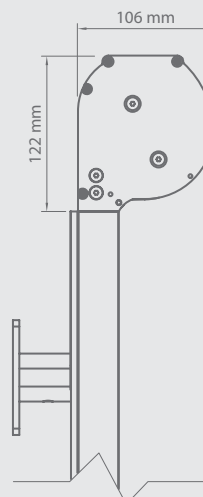



Properties:

- *Cassette made of extruded aluminium*
- *Revision from the front of the cassette*
- *Extruded aluminium sideguides*
- *Special arm creating the maximum tilt angle of 135°*
- *Wide range of fabrics*
- *Manual or electric drive*
- *Self-supporting option available*
- *Construction available in any colour from RAL palette (optional)*
- *Wind class of the product increased to 2 for max. size: width 2.6 m and height 3.2 m*
- *Option to create modules using common guide rail and modular brackets*

REFLEKSOL 95

Colour	RAL
Electric drive	yes
Manual drive	no
Maximum width	3.5 m
Maximum height	4.0 m
External use	yes
Internal use	yes

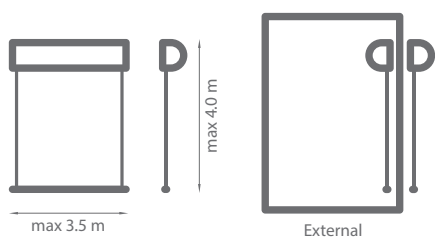

Group installation

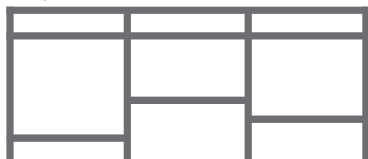

Standard construction colours:



Colours from SELT palette
pages: 150-151



Cassette dimensions

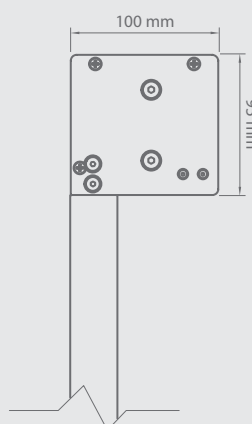



Properties:

- *Cassette for niche or wall installation made from extruded aluminium*
- *Extruded aluminium sideguides*
- *Revision from the front of the cassette*
- *Wide range of fabrics*
- *Electric drive*
- *Self-supporting system*
- *Option to connect systems through modular guide rail*
- *Construction available in any colour from RAL palette (optional)*

REFLEKSOL 90

Colour	RAL
Electric drive	yes
Manual drive	yes
Use - extruded sideguides	
• maximum width	3 m
• maximum height	4 m
External use - cable guides	
• max. width and height	3 m
Internal use - cable guides	
• maximum width	3 m
• maximum height	4 m

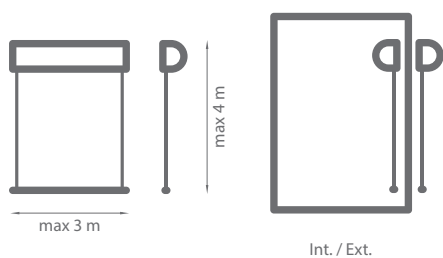

Standard construction colours:



Colours from SELT palette
pages: 150-151



Cassette dimensions

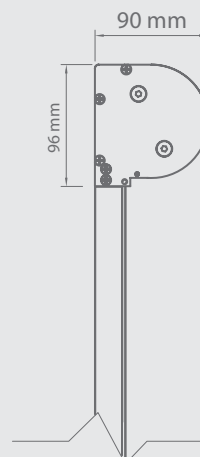



Properties:

- *Cassette made of extruded aluminium*
- *Revision available from the front of the cassette*
- *Extruded aluminium sideguides or cable guides from stainless steel*
- *Anti-wind bars option available*
- *Wide range of fabrics*
- *Manual or electric drive*
- *Dedicated for the wall, niche and facade installation*
- *Self-supporting option available*
- *Construction available in any colour from RAL palette (optional)*
- *Self-supported system only with G31 and G80 guide rails*

REFLEKSOL 85 SA/MA

Colour	RAL
Electric drive	no
Manual drive	yes
Maximum width SA	2.2 m
Maximum width MA	2.5 m
Maximum height SA	2.5 m
Maximum height MA	3.0 m
External use	no
Internal use	yes



Standard construction colours:



Colours from SELT palette
pages: 150-151

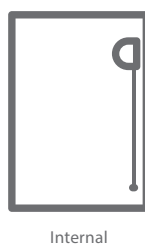
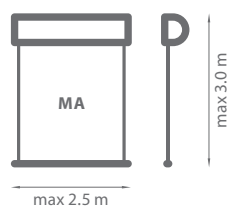
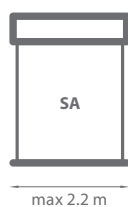

Cassette dimensions

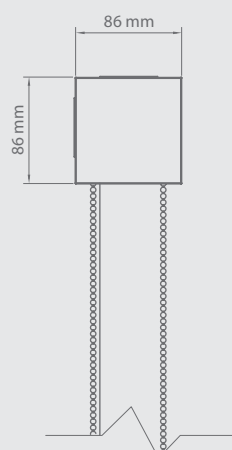



Properties:

- *Square-shaped cassette made of extruded aluminium*
- *Free-hanging system*
- *Internal installation*
- *Wide range of fabrics*
- *Plastic cassette end caps*
- *Operation by a chain R85 MA*
- *Operation by a chain or special bottom bar R85 SA*
- *Self-braking mechanism (only R85 SA)*
- *Construction available in any colour from RAL palette (optional)*
- *Chain protection elements included*

REFLEKSOL 85 A

Colour	RAL
Electric drive	yes
Manual drive	no
Maximum width	2.6 m
Maximum height	2.6 m
External use	no
Internal use	yes

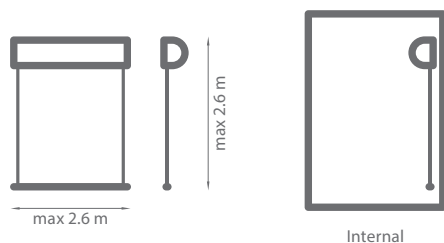

Standard construction colours:



Colours from SELT palette
pages: 150-151



Cassette dimensions

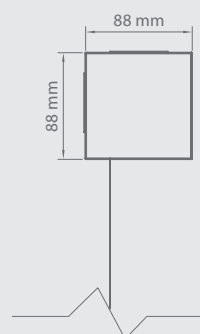



Properties:

- *Square-shaped cassette made of extruded aluminium*
- *Aesthetic aluminium end caps in colour of the cassette*
- *Free-hanging system*
- *Internal installation*
- *Wide range of fabrics*
- *Electric operation*
- *Construction available in any colour from RAL palette (optional)*

REFLEKSOL 76

Colour	RAL
Electric drive	yes
Manual drive	yes
Maximum width	2.6 m
Maximum height	2.6 m
External use	yes
Internal use	yes

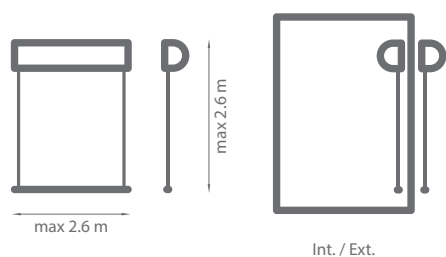

Standard construction colours:



Colours from SELT palette
pages: 150-151

Cassette dimensions

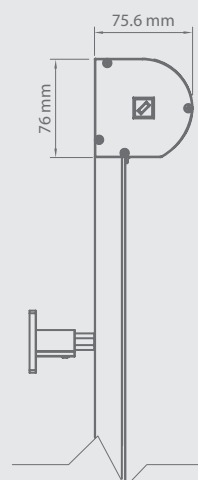



Properties:

- *Cassette made of extruded aluminium*
- *Plastic end caps*
- *Revision from the back of the cassette*
- *Extruded aluminium sideguides or cable guides from stainless steel*
- *Wide range of fabrics*
- *Manual or electric drive*
- *Dedicated to the wall, niche and facade installation*
- *Self-supporting option available*
- *Construction available in any colour from RAL palette (optional)*

REFLEKSOL XXL

Colour	RAL
Electric drive	yes
Manual drive	yes
External use	yes
• max. width and height	3.0 m
Internal use	yes
• maximum width	4.5 m
• maximum height	5.0 m

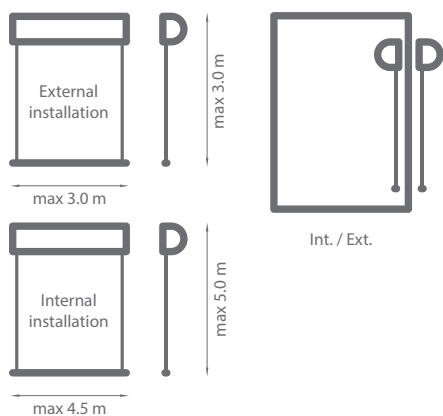

Standard construction colours:



Colours from SELT palette
pages: 150-151



Wall/ceiling bracket dimensions

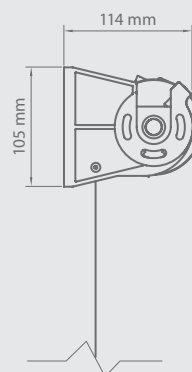



Properties:

- *System without cassette*
- *Cable guides made of stainless steel*
- *Free-hanging system available only in internal installation option*
- *Various bottom bars available*
- *Wide range of fabrics*
- *Manual or electric drive*
- *Wall or ceiling installation*
- *Construction available in any colour from RAL palette (optional)*

REFLEKSOL XL

Colour	RAL
Electric drive	yes
Manual drive	yes
Internal use	yes
• max. width and height	4 m
External use	yes
• max. width and height	3 m

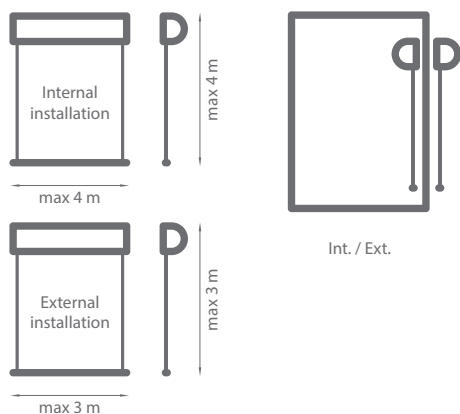

Standard construction colours:



Colours from SELT palette
pages: 150-151



Wall/ceiling bracket dimensions

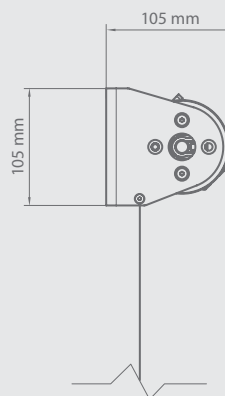



Properties:

- System without cassette
- Aluminium brackets
- Cable guides made of stainless steel
- Free-hanging system available only in internal installation option
- Various bottom bars available
- Wide range of fabrics
- Manual or electric drive
- Wall or ceiling installation
- Construction available in any colour from RAL palette (optional)

REFLEKSOL XL MA

Colour	RAL
Electric drive	no
Manual drive	yes
Maximum width	3.0 m
Maximum height	3.5 m
External use	no
Internal use	yes

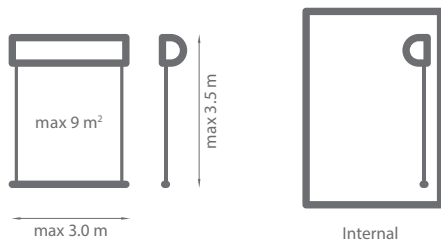

Standard construction colours:



Colours from SELT palette
pages: 150-151



Wall/ceiling bracket dimensions

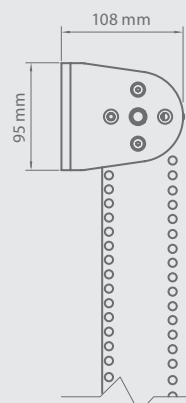



Properties:

- *System without cassette*
- *Aluminium brackets*
- *Cable guides made of stainless steel or free-hanging system*
- *Wide range of fabrics*
- *Manual drive operated by a metal ball chain*
- *Wall or ceiling installation*
- *System dedicated for internal installation*
- *Construction available in any colour from RAL palette (optional)*
- *Chain safety bracket included*

REFLEKSOL XS

Colour	RAL
Electric drive	yes
Manual drive	yes
Maximum width	2.6 m
Maximum height	2.6 m
External use	no
Internal use	yes

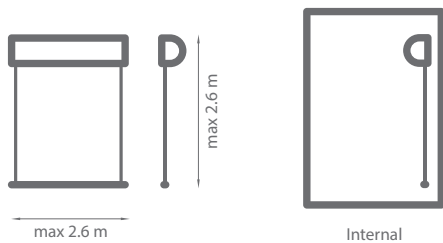

Standard construction colours:



Colours from SELT palette
pages: 150-151



Wall/ceiling bracket dimensions

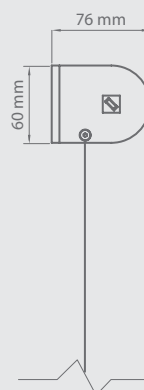



Properties:

- *System without cassette*
- *Small aluminium brackets*
- *Cable guides made of stainless steel or free-hanging system*
- *Various bottom bars available*
- *Wide range of fabrics*
- *Manual or electric drive*
- *Wall or ceiling installation*
- *System dedicated for internal installation only*
- *Construction available in any colour from RAL palette (optional)*





SYSTEM VERANDA

SYSTEM VERANDA

Colour	RAL
Electric drive	yes
Manual drive	no
Maximum width*	4.5 m
Maximum height*	5.0 m

* Detailed information available in the price list

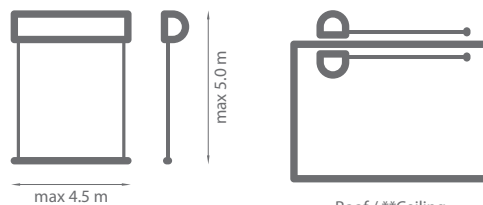

Roof / **Ceiling
** At the customer's request

Standard construction colours:



Colours from SELT palette
pages: 150-151

Group installation

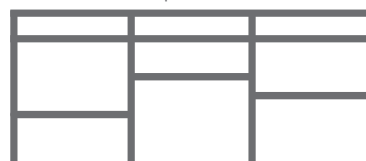

Basic dimensions (mm)

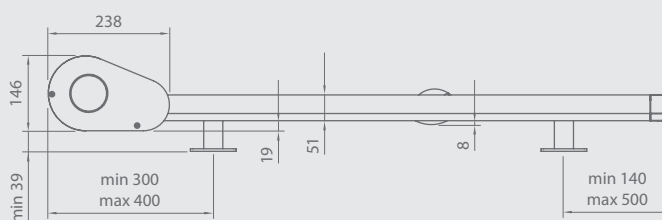



Properties:

- *Construction from extruded aluminium*
- *Fabric tensioning system is placed in the bottom bar*
- *Roof mounting and the possibility of mounting in a suspended version (ceiling) at the request of the customer*
- *Wide range of fabrics*
- *Electric drive*
- *Construction available in any colour from RAL palette (optional)*
- *Modular installation available*

SYSTEM VERANDA FTS

Colour	RAL
Electric drive	yes
Manual drive	no
Maximum width*	4.5 m
Maximum height*	6.5 m

* Detailed information available in the price list

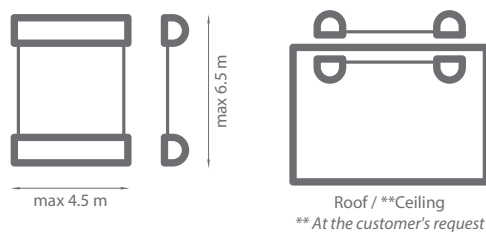

Standard construction colours:



Colours from SELT palette
pages: 150-151

Group installation



Basic dimensions (mm)

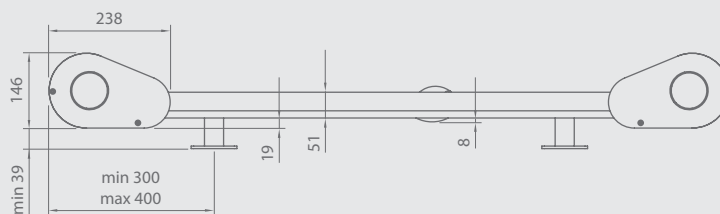



Properties:

- *Construction made of extruded aluminium*
- *Modular installation available*
- *Two motors with built-in load sensors*
- *Roof mounting and the possibility of mounting in a suspended version (ceiling) at the request of the customer*
- *The possibility of covering large areas without the need to divide the system*
- *Wide range of fabrics*
- *Electric drive*
- *Construction available in any colour from RAL palette (optional)*





AWNINGS

TERRACE AWNING DAKAR



Colour	RAL
Electric drive	yes
Manual drive	yes
Maximum width	6.0 m
Maximum projection	3.6 m
Cassette	yes
Tilt angle	5°–40°
Fabric	150 patterns
Valance	yes

Standard construction colours:

- RAL 9010 mat ● RAL 9006 mat
- RAL 1015 mat ● RAL 8014 mat
- FSM 71319

Cranks and gears are available in colours:
RAL 9010, RAL 1013, RAL 8017, RAL 9006, RAL 7016.

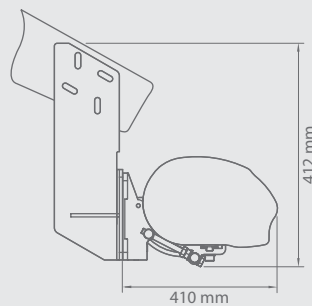
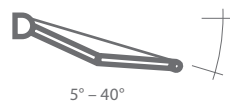
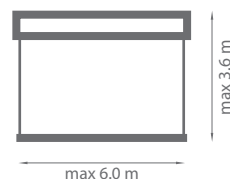

Roof rafter installation

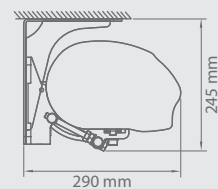

Ceiling installation

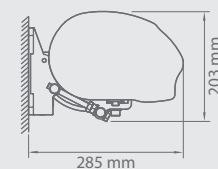

Wall installation



Properties:

- *Construction made from extruded aluminium*
- *Flyer's chains in the arms*
- *Roller tube support*
- *Cassette protects the fabric from weather conditions*
- *The use of gasket in the cassette additionally protects the fabric*
- *Possibility of using telescopic front bar support*
- *Simple handling using full weather automation*
- *Dedicated telescopic support - standard version*

TERRACE AWNING CASABLANCA



Colour	RAL
Electric drive	yes
Manual drive	yes
Maximum width	6.0 m
Maximum projection	3.6 m
Cassette	yes
Tilt angle	5°–40°
Fabric	150 patterns
Valance	no

Standard construction colours:

- RAL 9010 mat ● RAL 9006 mat
- RAL 1015 mat ● RAL 8014 mat
- FSM 71319

Cranks and gears are available in colours:
RAL 9010, RAL 1013, RAL 8017, RAL 9006, RAL 7016.

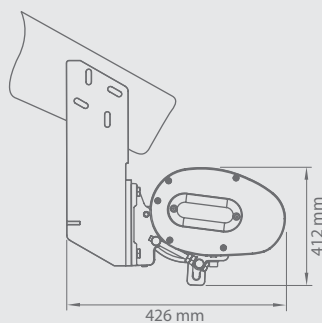
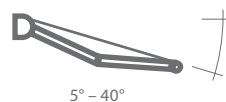
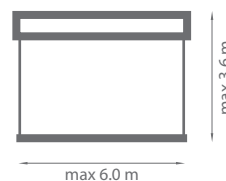

Roof rafter installation

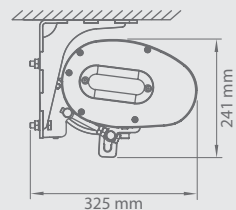

Ceiling installation

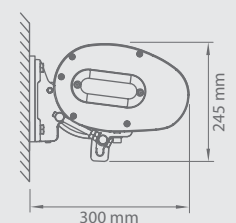

Wall installation



Properties:

- *Construction made from extruded aluminium*
- *Flyer's chains in the arms*
- *Roller tube support with big widths*
- *Cassette protecting the fabric from weather conditions*
- *The use of gasket in the cassette additionally protects the fabric*
- *Aluminium end caps*
- *Simple handling using full weather automation*

TERRACE AWNING PALLADIO



Colour	RAL
Electric drive	yes
Manual drive	yes
Maximum width	7.0 m
Maximum projection	3.6 m
Cassette	yes
Tilt angle	5°–50°
Fabric	150 patterns
Valance	yes

Standard construction colours:

- RAL 9010 mat ● RAL 9006 mat
- RAL 1015 mat ● RAL 8014 mat
- FSM 71319 ● RAL 9005 str

Cranks and gears are available in colours:
RAL 9010, RAL 1013, RAL 8017, RAL 9006, RAL 7016.

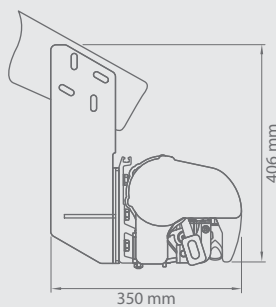
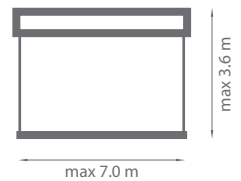

Roof rafter installation

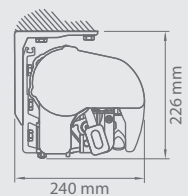

Ceiling installation

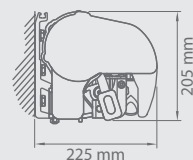

Wall installation



Properties:

- *Construction made from extruded aluminium*
- *Flyer's chains in the arms*
- *Square bar*
- *Additionally strengthened cassette*
- *Cassette protects the fabric from weather conditions*
- *Supporting square bar facilitates installation*
- *Simple handling using full weather automation*
- *Possibility of using telescopic front bar support*
- *Set of overlapping arms with maximum projection of 3.1 m*

TERRACE AWNING CORSIKA



Colour	RAL
Electric drive	yes
Manual drive	no
Maximum width	7.0 m
Maximum projection	3.6 m
Cassette	yes
Tilt angle	5°–35°
Fabric	150 patterns
Valance	no

Standard construction colours:

- RAL 9010 mat
- RAL 9006 mat
- RAL 1015 mat
- RAL 8014 mat
- FSM 71319

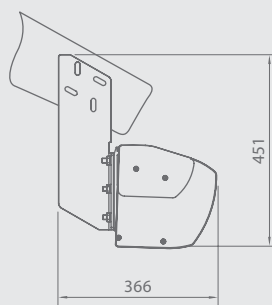
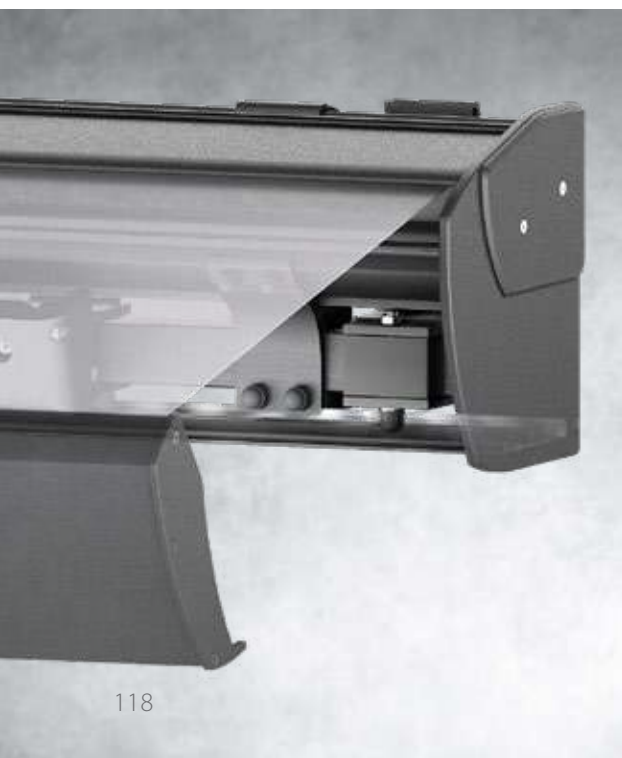
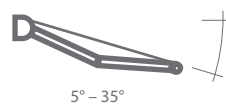
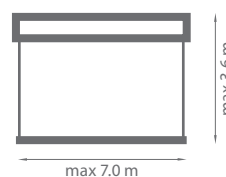

Roof rafter installation

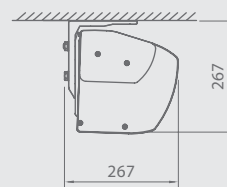

Ceiling installation

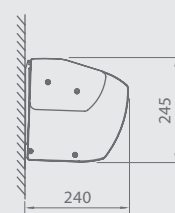

Wall installation



Properties:

- *Construction made from extruded aluminium*
- *Flyer's chains in the arms*
- *Square supporting beam making the installation easier*
- *Cassette protecting the fabric from weather conditions*
- *Square bare facilitates the installation*
- *Simple handling using full weather automation*
- *Aluminium end caps*
- *LED lighting in lower profile*

TERRACE AWNING JAMAICA

Optional hood



* Max. 5.9m width and 3.1m projection when with Volant

Colour	RAL
Electric drive	yes
Manual drive	yes
Maximum width*	7.0 m
Maximum projection*	3.6 m
Cassette	no
Optional hood	yes
Tilt angle	5°–40°
Fabric	150 patterns
Valance	yes
Volant valance - with manual drive	yes
• maximum height for soltis fabrics	1.5 m
• maximum height for acrylic fabrics	1.2 m

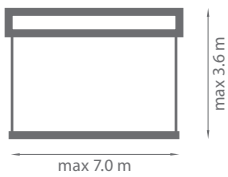

Standard construction colours:

- RAL 9010 mat
- RAL 9006 mat
- RAL 1015 mat
- RAL 8014 mat
- FSM 71319

Cranks and gears are available in colours:
RAL 9010, RAL 1013, RAL 8017, RAL 9006, RAL 7016.

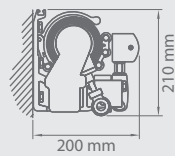

Wall installation

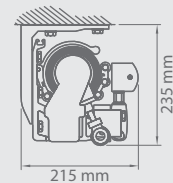

Ceiling installation

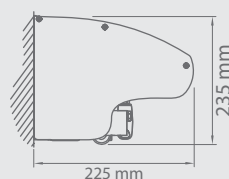

Wall installation -
option with hood

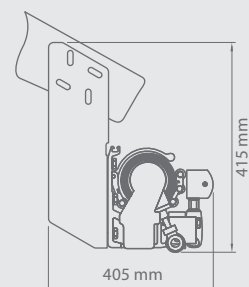

Roof rafter installation



Properties:





- Construction made from extruded aluminium
- Flyer's chains in the arms
- Square supporting beam making the installation easier
- Roller tube support with big widths
- Optional hood protects the rolled fabric from weather conditions
- The use of Volant - roll-up valance: not only additionally protects against the sun, but also increases a sense of privacy
- Simple handling using full weather automation
- Possibility of using telescopic support
- Set of overlapping arms with maximum projection of 3.1 m

TERRACE AWNING AUSTRALIA



Colour	RAL
Electric drive	yes
Manual drive	yes
Maximum width	7.0 m
Maximum projection	3.6 m
Cassette	no
Optional hood	no
Tilt angle	5°-60°
Fabric	150 patterns
Valance	yes

Standard construction colours:

-  RAL 9010 mat
-  RAL 9006 mat
-  RAL 1015 mat
-  RAL 8014 mat
-  FSM 71319

Cranks and gears are available in colours:
RAL 9010, RAL 1013, RAL 8017, RAL 9006, RAL 7016.

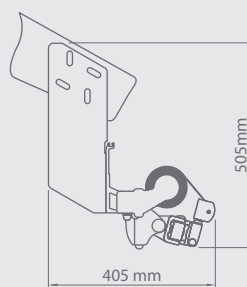
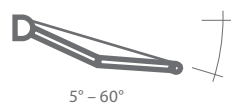
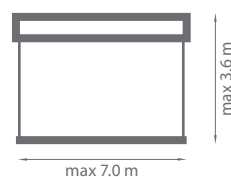

Roof rafter installation

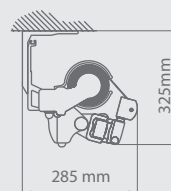

Ceiling installation

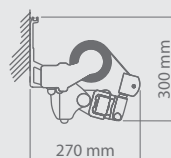

Wall installation



Properties:

- *Construction made from extruded aluminium*
- *Flyer's chains in the arms*
- *Square supporting beam making the installation easier*
- *Roller tube support with big widths*
- *Supporting bar facilitating installation*
- *The construction allows for installation even with limited space*
- *Simple handling using full weather automation*
- *Possibility of using telescopic front bar support*
- *Set of overlapping arms with maximum projection of 3.1 m*

TERRACE AWNING SILVER PLUS



Optional hood

Colour	RAL
Electric drive	yes
Manual drive	yes
Maximum width	5.3 m
Maximum projection	2.5 m
Cassette	no
Optional hood	yes
Tilt angle	5°-40°
Fabric	150 patterns
Valance	yes

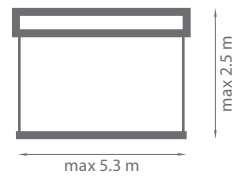

Standard construction colours:

● RAL 9010 mat

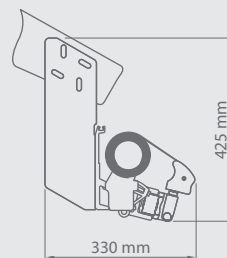
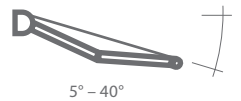

Roof rafter
installation

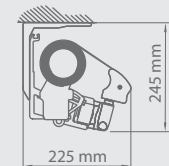

Ceiling installation

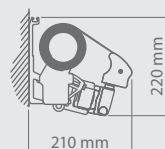

Wall installation

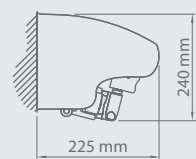

Wall installation -
option with hood



Properties:





- *Construction made from extruded aluminium*
- *Flyer's chains in the arms*
- *Square supporting beam making the installation easier*
- *Roller tube support with big widths*
- *Construction allows the installation even at a small mounting space*
- *Simple handling using full weather automation*
- *Possibility of using telescopic support*
- *Possibility of using overlapping arms*

TERRACE AWNING MALTA



Colour	RAL
Electric drive	yes
Manual drive	yes
Maximum width	5.0 m
Maximum projection	3.1 m
Cassette	no
Optional hood	no
Tilt angle	5°-70°(wall) 5°-85°(ceiling)
Fabric	150 patterns
Valance	yes

Standard construction colours:

-  RAL 9010 mat
-  RAL 9006 mat
-  RAL 1015 mat
-  RAL 8014 mat
-  FSM 71319

Cranks and gears are available in colours:
RAL 9010, RAL 1013, RAL 8017, RAL 9006, RAL 7016.



5° - 70° wall installation
5° - 85° ceiling installation

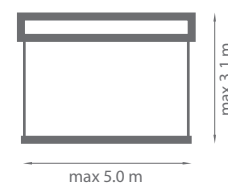

* for 5.0m width maximum projection is 1.6m

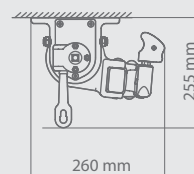

Ceiling installation

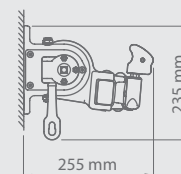

Wall installation



Properties:

- *Construction made from extruded aluminium*
- *Flyer's chains in the arms*
- *Universal brackets for wall and ceiling installation*
- *Simplified mechanism of tilt angle regulation*
- *Simple handling using full weather automation*
- *Possibility of using telescopic front bar support*

SIDE SCREEN BORA

Colour	RAL
Electric drive	no
Manual drive	yes
Maximum height	2.0 m
Minimum height	1.1 m
Maximum projection	4.0 m
Cassette	yes
Fabric	150 patterns

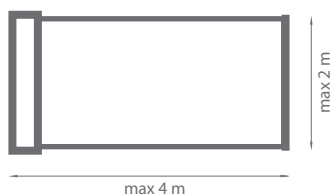

Standard construction colours:

- RAL 9010 mat
- RAL 9006 mat
- RAL 1015 mat
- RAL 8014 mat
- FSM 71319



Cassette cross-section

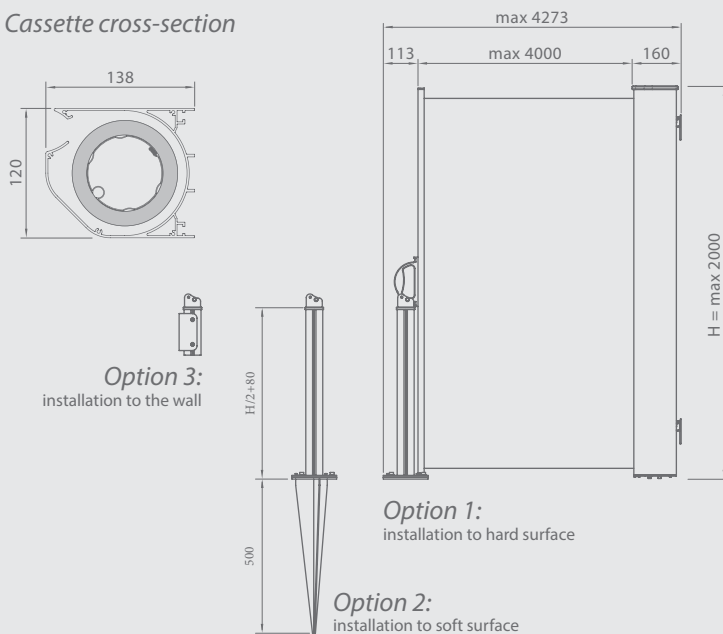



Properties:

- *Construction made from extruded aluminium*
- *Cassette protects the fabric from weather conditions*
- *Three types of front bar mounting:*
 - Option 1: to hard surface*
 - Option 2: to soft surface*
 - Option 3: to the wall*
- *In versions 1 and 2 there is a neodymium magnet stabilizing the beam to the post*

BALCONY AWNING ITALIA BOX

Colour	RAL
Electric drive	yes
Manual drive	yes
Maximum width	5.0 m
Maximum projection	1.4 m
Cassette	yes
Tilt angle*	90°
Fabric	150 patterns
Valance	yes

* 140° on request

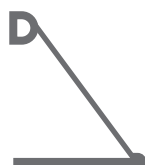

Standard construction colours:

- RAL 9010 mat
- RAL 9006 mat
- RAL 1015 mat
- RAL 8014 mat
- FSM 71319

Cranks and gears are available in colours:
RAL 9010, RAL 1013, RAL 8017, RAL 9006, RAL 7016.

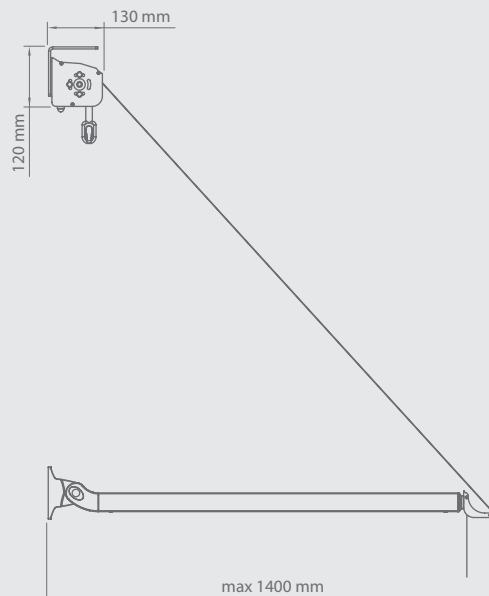



Properties:

- Construction made from extruded aluminium
- Cassette protects the fabric from weather conditions
- Easy installation thanks to brackets and separately mounted arms
- Spring in the arms tightens the fabric and prevents the arms from folding under wind pressure
- Simple handling using full weather automation

BALCONY AWNING ITALIA

Colour	RAL
Electric drive	yes
Manual drive	yes
Maximum width	5.0 m
Maximum projection	1.8 m
Cassette	no
Optional hood	no
Tilt angle*	90°
Fabric	150 patterns
Valance	yes

* 160° on request



max 5.0 m

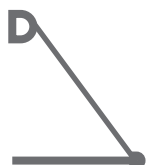

max 1.8 m



Standard construction colours:

○ RAL 9010 mat ● RAL 9006 mat

● RAL 1015 mat ● RAL 8014 mat

● FSM 71319

Cranks and gears are available in colours:
RAL 9010, RAL 1013, RAL 8017, RAL 9006, RAL 7016.

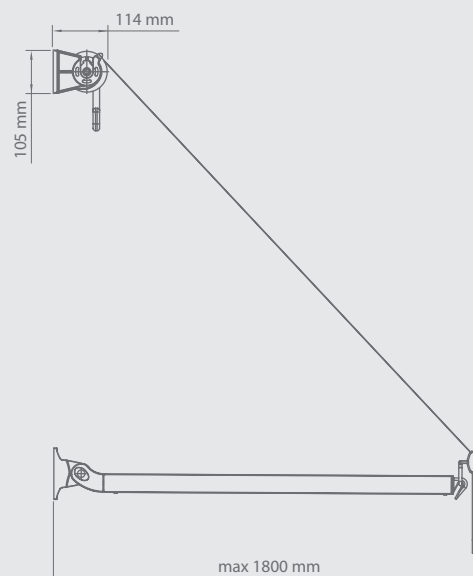



Properties:

- *Construction made from extruded aluminium*
- *Easy installation thanks to separately mounted brackets and arms*
- *Spring in the arms tightens the fabric and prevents the arms from folding under wind pressure*
- *Simple handling using full weather automation*

BALCONY AWNING

ITALIA BALCONY

Colour	RAL
Electric drive	no
Manual drive	yes
Maximum width	5.0 m
Maximum projection	0.7 m
Cassette	no
Optional hood	no
Tilt angle*	90°
Fabric	150 patterns
Valance	yes

* Maximum tilt angle depends on arms installation place



max 5.0 m

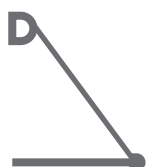

max 0.7 m



Standard construction colours:

○ RAL 9010 mat ● RAL 9006 mat

● RAL 1015 mat ● RAL 8014 mat

● FSM 71319

Cranks and gears are available in colours:
RAL 9010, RAL 1013, RAL 8017, RAL 9006, RAL 7016.

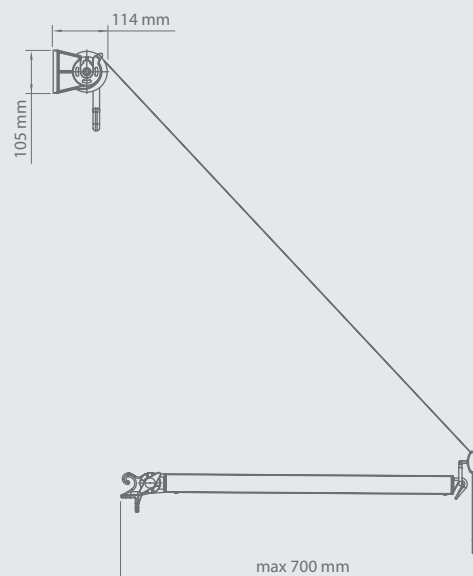



Properties:

- *Construction made from extruded aluminium*
- *Arms designed for handrail installation*
- *Brackets at both ends of the arms allow for two options of fastening the fabric*
- *Possibility to set appropriate tilt angle thanks to the construction of arms (arms lock)*

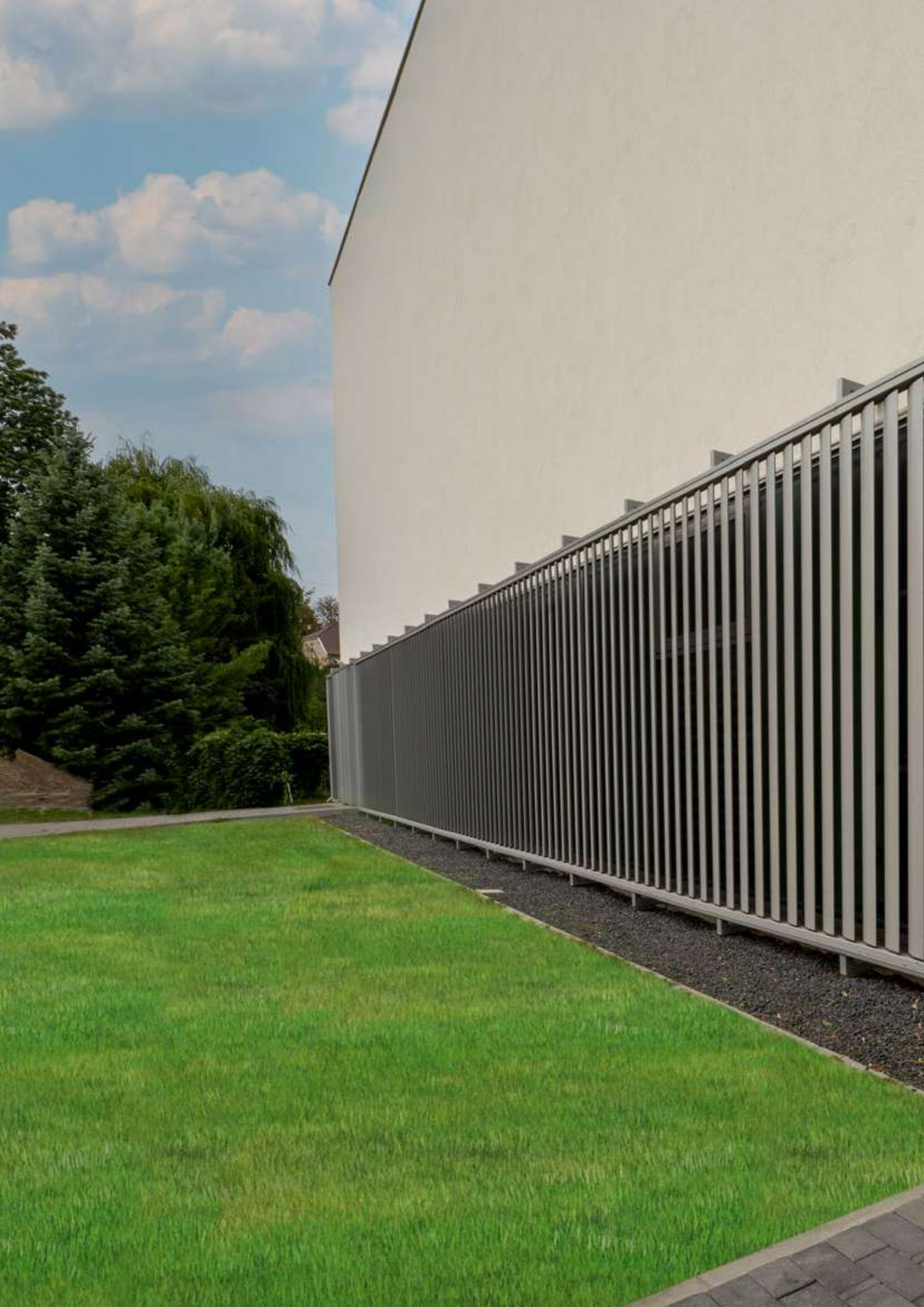



SYSTEM
SUNBREAKER

SYSTEM

SUNBREAKER 300 ROTARY

Colour	RAL
Electric drive	yes
Manual drive	no
Maximum width	4.5 m
Maximum height	7.0 m
External use	yes
Internal use	no
The ability to change the angle of blades	yes

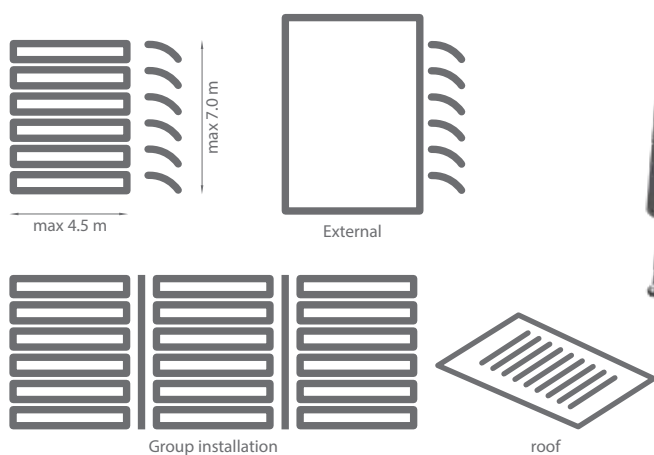

Standard construction colours:



Colours from SELT palette
pages: 150-151



Blade cross-section

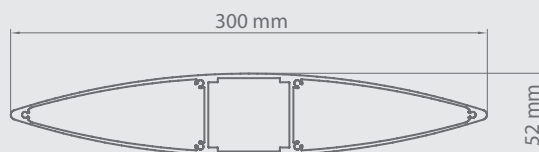



Properties:

- Construction made from extruded aluminium
- Elliptic blades width of 300 mm
- Group installation option
- The ability to change the angle of blades from approx. 0° to 100°
- Operated by linear motor
- System is installed onto external supporting facade construction
- Construction can be painted in any colour from RAL palette (optional)
- Bearing of the blades in the guides and the design of the drive unit components ensures silent operation of the system during movement
- Brackets for self-supporting side guides

SYSTEM

SUNBREAKER 300 FIXED

Colour	RAL
Electric drive	no
Manual drive	no
Maximum length of blade*	7 m
Maximum height	-
External use	yes
Internal use	no
The ability to change the angle of blades	yes (predefined)

* Spacing between brackets 4.0 m

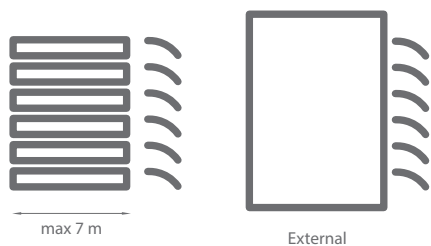

Standard construction colours:



Colours from SELT palette
pages: 150-151





Properties:

- *Lightweight blades made from extruded aluminium*
- *Enables shading horizontal and vertical surfaces*
- *Elliptic blade width of 300 mm*
- *Application of brackets mounted directly to the base allows to choose distance of blades during installation, no need to define it at the order stage*
- *Brackets are made of extruded aluminium, provide high endurance and fast installation*
- *The ability to adjust the blade angle in the range of 90° (each 15°)*
- *Blade end caps made of aluminium*
- *System can be painted in any colour from RAL palette (optional)*

SYSTEM

SUNBREAKER 210 ROTARY

Colour	RAL
Electric drive	yes
Manual drive	yes
Maximum width	4.00 m
Maximum height	6.02 m
External use	yes
Internal use	no
The ability to change the angle of blades	yes



Types of installation:

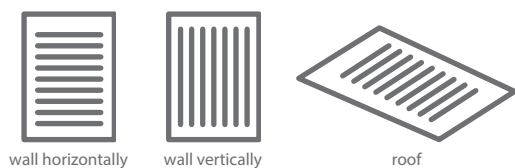

Standard construction colours:



Colours from SELT palette
pages: 150-151



Blade type A cross-section

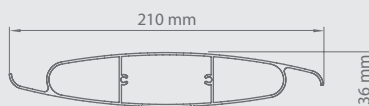

Blade type B cross-section

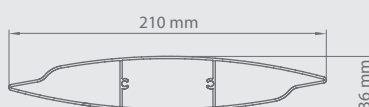



Properties:

- Construction made from extruded aluminium
- Two types of 210 mm width blades: Type A blade is designed for horizontal surfaces (roofing, skylights). Owing to the special shape of the blade when in the closed position, it provides protection from rain. Type B blade is designed for shading horizontal and vertical surfaces (building facades, pergola walls)
- Lightweight aluminium construction for strength and durability
- Rotation range up to 90° from the initial position of blades
- Possibility of mounting in vertical or horizontal position
- Controlling the angle of the blades with a linear motor
- Construction can be painted in any RAL color (option)

SYSTEM

SUNBREAKER 210 FIXED

Colour	RAL
Electric drive	no
Manual drive	no
Maximum width*	7 m
Maximum height	-
External use	yes
Internal use	no
The ability to change the angle of blades	yes (predefined)

* Spacing between brackets 3.0 m

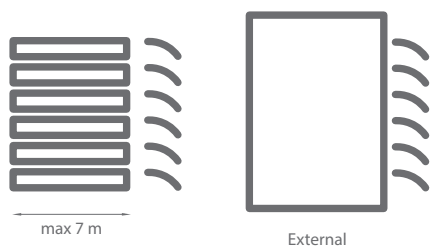

Standard construction colours:



Colours from SELT palette
pages: 150-151

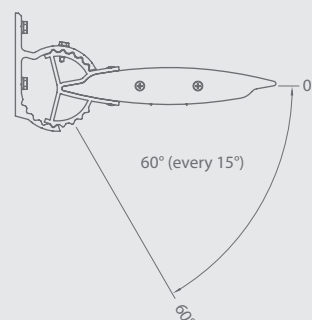
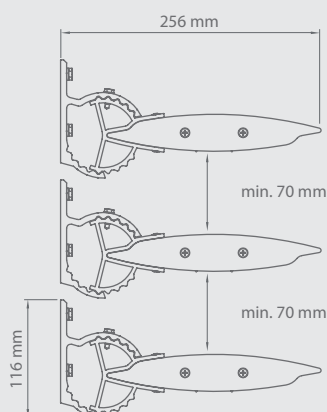



Properties:

- Construction made from extruded aluminium
- Elliptic blades 210 mm wide
- Enables shading horizontal and vertical surfaces
- Application of brackets mounted directly to the base allows to choose distance of blades during installation, no need to define it at the order stage
- Brackets are made of extruded aluminium, provide high endurance and fast installation
- Ability to adjust the blade angle in the range of 60° (each 15°)
- Blade end caps made of aluminium
- System can be painted in any colour from RAL palette (optional)
- Various blade end caps available





POWDER COATING



1

2

COATING FINISH

1. "fine structure - pearl mat"
2. "fine structure"
3. satin finish
4. mat finish
5. "artificial anode"

3

4

5





CONSTRUCTION COLOURS

RAL 9005 MAT

Presented colour chart shows colours available within Selt collection for powder coated construction elements of Refleksols, venetian blinds and sunbreakers. Conditions of painting in colors included in the above collection and in other RAL colours – according to rules described in price lists of individual products. Because of technical and production reasons as well as due to different coating techniques, differences in colours between product components are possible. Presented pictures are for illustration purposes only. Colours may vary from actual ones. Any difference in shade does not constitute grounds for complaint.



SLATS COLOURS

Standard slat gloss 80% (satin)
* gloss 60% (semi-matt)

Presented colour chart shows slat colours available within SELT collection. Conditions of painting in colors within Selt collection and other RAL colours – according to rules described in price list of venetian blinds. Because of technical and production reasons as well as due to different coating techniques, differences in colours between product components are possible. Presented pictures are for illustration purposes only. Colours may vary from actual ones. Any difference in shade does not constitute grounds for complaint. Customized perforation (layout and size of openings) and painting in colours outside of SELT collection are subject to individual arrangements in terms of price and conditions of implementation.





FABRICS

AWNING FABRICS



100%
ACRYLIC



Above pictograms apply to acrylic fabrics.



ACRYLIC FABRICS

Acrylic fabrics guarantee the highest quality of the product, providing thermal comfort and protection against UV radiation. Made 100% out of acrylic fibre, dyed in chemical solution, provide excellent protection against colour loss. UV resistance coefficient is 7-8 at 8° scale. Impregnation with use of TEFLON® or SCOTCHGARD™ agents provides an excellent protective barrier and strengthens water-repellent qualities of the fabric, also preventing dirt adhering. Resistance to leaking: 330 mm water column. The advantage of acrylic fabric is also high resistance to tensile and tear. Permeability to air and water repellency Above pictograms apply to acrylic fabrics.

Technical data shown below are average values		
Fabric:	-	Acrylic 100%, solution dyed
Finishing:	-	Teflon - Cleangard
Weight:	DIN EN 12127	~ 300 g/m ²
Width:	DIN EN 1773	120 cm
Colour fastness:	DIN EN ISO 105-B02	7-8 / 8
Light fastness:	DIN EN ISO 105-B04	7-8/8
Oil repellency:	EN ISO 14419	4-5
Water repellency:	EN ISO 4920	100
Water column:	EN 20 811	~ 330 mm
Tensile strength (daN/5 cm):	DIN EN ISO 13934-1	~ 140 / 95
Tear resistance (daN) Weft / Warp:	EN ISO 13973-2	2.3 / 4

WATERPROOF ACRYLIC FABRICS

Waterproof acrylic fabrics are characterized by increased resistance to leaking ~1000 mm water column height. Weave structure together with modern impregnation technology provides high air permeability even on hot days. Oeko-Tex® guarantees that offered acrylic fabrics, subjected to special impregnation for water resistance, are not toxic.

Technical data shown below are average values		
Fabric:	-	Acrylic 100%, solution dyed
Finishing:	-	Teflon - Cleangard
Weight:	DIN EN 12127	~ 330 g/m ²
Width:	DIN EN 1773	120 cm
Colour fastness:	DIN EN ISO 105-B02	7-8 / 8
Light fastness:	DIN EN ISO 105-B04	7-8/8
Oil repellency:	EN ISO 14419	4-5
Water repellency:	EN ISO 4920	100
Water column:	EN 20 811	~ 1000 mm
Tensile strength (daN/5 cm):	DIN EN ISO 13934-1	~ 140 / 95
Tear resistance (daN) Weft / Warp:	EN ISO 13973-2	3 / 4



REFLEKSOL FABRICS

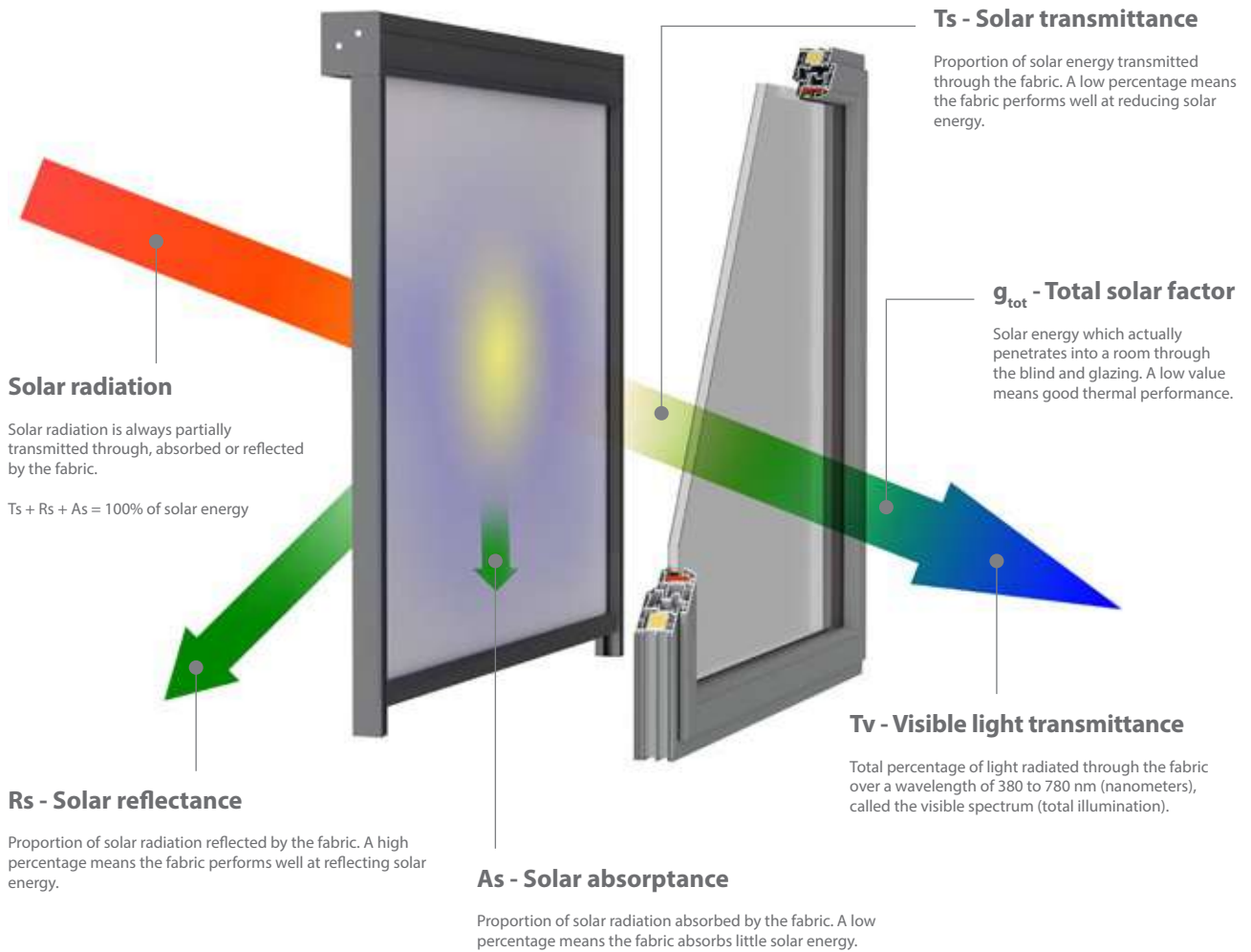

OPENNES FACTOR

Relative area of the openings in the fabric. It is considered as independent of the colour. For fabric with the same weave, it should be measured using the darkest colour in the range.

SERGE 1% / SERGE 600

Collection of fabrics made from fiberglass covered with PVC. Fabrics made of this group have a distinctive diagonal „serge” weave, which guarantees them an unusual dimensional stability. High fire resistance and very good technical parameters of fabrics provide users with visual comfort in rooms, thus protecting against overheating the interior.



POLYSCREEN

Wide group of technical polyester fabrics coated with PVC, characterized by variety of weaving patterns and properties (PS Luminous, PS 550, PS 350). This allows architects to select the right solution, increasing visual attractiveness of the building and to emphasize its individual character. High technical parameters provide optical and thermal comfort inside the room. An additional feature of the fabric is the ease to keep it clean.



SOLTIS 92 / SOLTIS 99

Polyester technical fabric coated with PVC, manufactured with patented technology Preconstraint Ferrari®. The unique technology gives fabric high stability and protects it against deformations even in large size blinds. High technical parameters guarantee optical and thermal comfort. The quality components used in production of this fabric ensures color fastness. Thanks to the smooth surface, the fabric is difficult to absorb dirt or get stained.

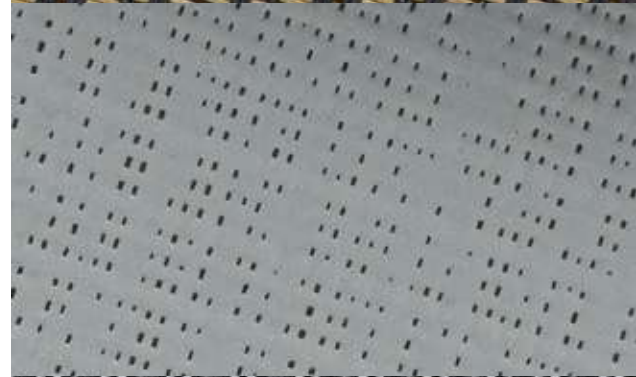

BLACK OUT

High-end blackout fabrics in group of Polyscreen 314 BO, effectively block sunlight coming into the room. It is ideal solution for conference rooms, audio-visual, photographic studios, etc. High dimensional stability, high technical parameters and interesting colours are without a doubt advantages of fabrics in this group.



ACOUSTIC - VEROGLIM

Elegant fabric, made from the highest quality non-flammable polyester fibers Trevira® CS, intended for indoor use. Because of its weight, the fabric is ideally suited for cassette systems. An important advantage of this fabric is high coefficient of acoustics. Thanks to its structure, the fabric absorbs sound and mutes the room. Another advantage is metallic surface that reflects bright light and in this way regulates its intensity in the room.



SUNWORKER

Smooth polyester fabric finished with PVC. Unique structure of the fabric effectively stops the sunlight, allowing for just optimal amount of visible light to transmit inside the room, providing high comfort to its users. The advantages of this fabric are: color fastness, high resistance to weather conditions and easy to maintain clean.



SOLID FABRICS

PRECONTRAIT 602 OPAQUE TECHNICAL SPECIFICATIONS

	Values	Standards
Yarn	1100 dtex PES HT	Tersuisse
Weight	750 g/m ²	EN ISO 2286-2
Width	267 cm	-
Tensile strength (warp/weft)	230/220 daN/5cm	EN ISO 1421
Tear strength (warp/weft)	20/20 daN	DIN 53.363
Elongation under load (warp/weft)	<1%/<1%	NF EN 15619
Adhesion	9/9 daN/5cm	EN ISO 2411
Finish	Varnish both sides	-
Flame retardancy	• M2/NFP 92-507 • B1/DIN4102-1 • M2/UNE23.727-90 • BS 7837 • 1530.3/AS NZS • Method 2/NFPA 701 • CSFM T19	
Cold resistance	-30°C	ISO 4675
Heat resistance	+70°C	

PRECONTRAIT 702 OPAQUE TECHNICAL SPECIFICATIONS

	Values	Standards
Yarn	1100 dtex PES HT	Tersuisse
Weight	830 g/m ²	EN ISO 2286-2
Width	267 cm	
Tensile strength (warp/weft)	280/280 daN/5 cm	EN ISO 1421
Tear strength (warp/weft)	30/28 daN	DIN 53.363
Adhesion	10/10 daN/5 cm	EN ISO 2411
Finish	Acrylic varnish both sides (aluminium face / back grey)	
Flame retardancy	M2/NFP 92-507 • TEST 2/NFPA 701 • CSFM T19 • B1/DIN 4102-1 • BS 7837 • GROUP 1/AS/NZS 3837 • 1530.3/AS/NZS • SITAC/SIS 650082 • Schwerbrennbar Q1-Tr1/ONORM A 3800-1 • CLASSE 2/UNI 9177-87 • M2/UNE 23.727-90 • VKF 5.2/SN 198898 • B-s2,do/EN 13501-1	
Cold resistance	-30°C	
Heat resistance	+70°C	



BLANC 602N OPAQUE 8503



BEIGE 602N OPAQUE 0020



ALU GREY 702 OPAQUE 1285



Control

Depending on your needs, the control of blinds can be performed by using wall switches, remote controls or via the internet through convenient interface in your computer, tablet or smartphone.



Sensors

The use of wind, solar or temperature sensors in the intelligent building gives you the ability to automatically control the sun blinds depending on the changing weather conditions.



Automation

comfort during
work and leisure





Electric drive

The use of electric drives in sun blinds gives you comfort of use but also the ability to program their automatic opening and closing.

Thanks to automated control system applied in sun blinds it is possible to control level of solar energy transmitted into the building. These are necessary and convenient solutions of controls used not only in the passive buildings. In order to increase energy efficiency and control comfort, it is possible to integrate lighting, air-conditioning and heating systems, and visualization of the current position of the sun blinds. Modern automation systems are characterized by simplicity to install, configure and reconfigure.



SELT

COMPANY

All specifications, design and color of products are up to date at time of forwarding this catalog to print. The manufacturer reserves the right to make changes without prior notice. Due to the printing process any color reproductions are for illustration purposes only, their deviation from the actual color cannot constitute grounds for complaint. Folder reproduction in whole or in part is forbidden without the written permission of SELT.

selt.com